



DEAS 1206: 2024

ICS 93.080.01

DRAFT EAST AFRICAN STANDARD

Geometrical design of roads — Code of practice

EAST AFRICAN COMMUNITY

Copyright notice

This EAC document is copyright-protected by EAC. While the reproduction of this document by participants in the EAC standards development process is permitted without prior permission from EAC, neither this document nor any extract from it may be reproduced, stored or transmitted in any form for any other purpose without prior written permission from EAC.

Requests for permission to reproduce this document for the purpose of selling it should be addressed as shown below or to EAC's member body in the country of the requester:

© East African Community 2024 — All rights reserved
East African Community
P.O. Box 1096,
Arusha
Tanzania
Tel: + 255 27 2162100
Fax: + 255 27 2162190
E-mail: eac@eachq.org
Web: www.eac-quality.net

Reproduction for sales purposes may be subject to royalty payments or a licensing agreement. Violators may be prosecuted.

Contents

Page

Foreword	iv
1 Scope	Error! Bookmark not defined.
2 Conformance	Error! Bookmark not defined.
3 Normative references	Error! Bookmark not defined.
4 Terms and definitions	Error! Bookmark not defined.
5 Symbols (and abbreviated terms).....	Error! Bookmark not defined.
6 Clause	Error! Bookmark not defined.
6.1 Subclause (level 1)	Error! Bookmark not defined.
6.1.1 Subclause (level 2)	Error! Bookmark not defined.
6.1.2 Subclause (level 2)	Error! Bookmark not defined.
6.2 Subclause (level 1)	Error! Bookmark not defined.
7 Clause	Error! Bookmark not defined.
8 Special	Error! Bookmark not defined.
Annex A (normative) Annex title	Error! Bookmark not defined.
A.1 General	Error! Bookmark not defined.
A.2 Clause	Error! Bookmark not defined.
A.2.1 Subclause (level 1)	Error! Bookmark not defined.
A.2.2 Subclause (level 1)	Error! Bookmark not defined.
A.3 Clause	Error! Bookmark not defined.
Annex B (informative) Which styles correspond to which element — Quick reference guide	Error! Bookmark not defined.
Bibliography	Error! Bookmark not defined.

Foreword

Development of the East African Standards has been necessitated by the need for harmonizing requirements governing quality of products and services in the East African Community. It is envisaged that through harmonized standardization, trade barriers that are encountered when goods and services are exchanged within the Community will be removed.

The Community has established an East African Standards Committee (EASC) mandated to develop and issue East African Standards (EAS). The Committee is composed of representatives of the National Standards Bodies in Partner States, together with the representatives from the public and private sector organizations in the community.

East African Standards are developed through Technical Committees that are representative of key stakeholders including government, academia, consumer groups, private sector and other interested parties. Draft East African Standards are circulated to stakeholders through the National Standards Bodies in the Partner States. The comments received are discussed and incorporated before finalization of standards, in accordance with the Principles and procedures for development of East African Standards.

East African Standards are subject to review, to keep pace with technological advances. Users of the East African Standards are therefore expected to ensure that they always have the latest versions of the standards they are implementing.

The committee responsible for this document is Technical Committee EASC/TC 028, *Construction of Roads, Rail, Air and Water Transport Infrastructure*.

Attention is drawn to the possibility that some of the elements of this document may be subject of patent rights. EAC shall not be held responsible for identifying any or all such patent rights.

Introduction

The geometric design of roadways deals with the dimensions and layout of visible features of a roadway with the objective of creating the roadway facility to the characteristic and behaviour of drivers, vehicles, traffic and terrain. Geometric design is based on specified design standards and controls which depend on a wide range of roadway system factors such as roadway functional classification, terrain of the area that the roadway traverses, levels of service, road user characteristics, vehicle characteristics (length, width, height, wheelbase, weight, including acceleration and deceleration characteristics and maximum speed) and design hourly traffic volume, sight distances and choice of horizontal and vertical alignment, road cross section, intersection type, available funds, safety, and social and environmental factors.

These factors are often interrelated. For instance, design speed depends on the functional classification which is usually related to expected traffic volume. The design speed may also depend on the terrain, particularly in cases where limited funds are available. In most cases, the principal factors used to determine the standards to which a particular roadway will be designed are the level of service to be provided, expected traffic volume, design speed, and the design vehicle. These factors, coupled with the basic characteristics of the driver, vehicle, and road, are used to determine standards for the geometric characteristics of the roadway, such as cross sections and horizontal and vertical alignments. Appropriate geometric design standards should be selected to maintain a desired level of service for a known proportional of different types of vehicles.

The use of geometric design standards fulfils three inter-related objectives. Firstly, standards are intended to provide minimum levels of safety and comfort for drivers; secondly, they provide the framework for economic design; and thirdly, they ensure a consistency of alignment. As noted above, the design standards adopted must take also into account the environmental road conditions, traffic characteristics, and driver behaviour.

It is expected that these guidelines of practice for or manual on roadway geometric design should include the following important aspects for proper roadway geometric design: Roadway functional classification, Design controls and criteria: these cover the characteristics of vehicles, road users, and traffic that act as criteria for the optimisation or improvement in design of the various road classes, Design elements: these are principal design elements which include sight distance, superelevation, horizontal and vertical alignments, and other elements of geometric design, They are joined together to create a facility that serves the traffic in a safe and efficient manner, consistent with the facility's intended function. Thus, each alignment element should complement others to produce a consistent, safe, and efficient design, Cross section elements, Intersections, Road furniture and other facilities.

The implementation of these guidelines will have the following impacts among others:

- a) It will ensure uniform roadway geometric standards and hence the optimum balance between road infrastructure construction cost and road user cost is obtained, considering road safety issues and natural and human environmental aspects in the EAC Region.
- b) It will improve efficiency of the road transport system by minimisation of road crashes and energy consumption.
- c) These guidelines recommend the width, height, wheelbase and minimum turning radius dimensions of vehicles such as the 22 m Interlinks, which have recently been permitted to traverse EAC road network, conform to the respective dimensions of the design vehicles documented in the existing design manuals for EAC Partner States and therefore will be accommodated by the existing intersections on the EAC road network. On the other side, all EAC Partner States will need to check whether headroom under bridge structures is appropriate (that is, complies with the recommended value of 5.5 m) and make improvements, if necessary.
- d) Furthermore, it is proposed that the recommended standards be implemented in all new road designs, and road rehabilitation, reconstruction and widening projects.

Geometrical design of roads — Code of practice

1 Scope

This Draft East African Standard provides general guidelines for geometrical design of roads.

It is applicable to all mobility and access roads of Class 1, Class 2, Class 3, Class 4 and Class 5 as explained in 5.1.

2 Normative references

The following documents are referred to in the text in such a way that some or all of their content constitutes requirements of this document. For dated references, only the edition cited applies. For undated references, the latest edition of the referenced document (including any amendments) applies.

There are no normative references in this document.

3 Terms and definitions

For the purposes of this document, the following terms and definitions apply.

ISO and IEC maintain terminological databases for use in standardization at the following addresses:

- IEC Electropedia: available at <http://www.electropedia.org/>
- ISO Online browsing platform: available at <http://www.iso.org/obp>

3.1

lane

portion of carriageway designed to accommodate a single line of moving road vehicles

3.2

traffic lane

part of a carriageway intended to accommodate a single stream of traffic in one direction

Note 1 to entry: A traffic lane can be bi-directional, such as a single lane road, a two-way turn/overtaking lane, or a reversible flow lane

Note 2 to entry: Some jurisdictions allow supplemental uses of a traffic lane, such as multiple motorcycles sharing the width of a traffic lane or allowing a bicycle to use the edge of a lane.

3.3

design speed

a selected speed used to determine the various geometric design features of the roadway to ensure a safe operation of vehicles.

Note 1 to entry: The design speed is the highest continuous speed at which individual vehicles can travel with safety on the road when weather conditions are favourable, traffic volumes are low and the design features of the road are the governing condition for safety.

**3.4
road reserve**

strip of land legally awarded to the roads agency, in which the road is or will be situated and where no other work or construction may take place without permission from the roads agency. The width is measured at right angle from the centreline of median to both sides of the roadway.

Note 1 to entry The diagrams illustrating road reserve are given in Figure 1a and Figure 1b

**3.5
specific road**

road leading to a specific facility and which branches off from:

- a) a national road; and
- b) a district and city road and a location where specific development activities are carried out.

**3.6
design vehicle**

vehicle with representative characteristics such as weight, dimensions and operating characteristics used to establish highway design controls for accommodating vehicles of the designated classes

**3.7
access control**

regulation of public access rights to and from properties abutting the highway facilities

**3.8
Levels of Service (LOS)**

qualitative measure that express the effectiveness of the road in terms of operating conditions. It is a measure of the effect of traffic flow factors, such as speed and travel time, interruptions, freedom of manoeuvre, driver comfort and convenience, and indirectly, safety and operation costs.

Note 1 to entry: Levels of Service (LOS) is a measure used to quantify traffic flow and congestion by assigning quality levels of traffic based on performance measure such as speed, density, etc.

**3.9
climbing lane**

auxiliary lane added outside the continuous lanes and has the effect of reducing congestion in the through lanes by removing slower-moving vehicles from the traffic stream, thereby maintaining capacity and freedom of operation on the carriageway

Note 1 to entry: The climbing lane is also referred to as a crawler lane, truck lane

**3.10
passing lane**

auxiliary lane that is added outside the continuous lanes and is typically provided on level sections of the route.

**3.11
clear zone**

unobstructed, relatively flat area provided beyond the edge of the roadway for the recovery of errant vehicles.

**3.12
median**

portion of a divided road separating the travelled ways for traffic in opposite directions including inside shoulders

3.13

headroom

required height to allow traffic to pass safely under objects restricting the height

3.14

intersection

as an area, shared by two or more roads, whose main function is to provide for the change of route directions.

3.15

grade separation

represents a crossing of two highways (or a highway and a railroad) at different levels

3.16

interchange

represents a system of interconnecting roadways, in conjunction with one or more grade separations, to provide for the movement of traffic between two or more roadways on different levels.

3.17

access road

lowest level of road in the network hierarchy with the function of linking traffic to and from community/public areas, either direct to adjacent urban centres or to the nearby road network;

3.18

unclassified road

roads that are not assigned to classes or categories

3.19

Average Daily Traffic (ADT)

total traffic volume during a given time period in whole days greater than one day and less than one year divided by the number of days in that time period

3.20

Average Annual Daily Traffic (AADT)

total yearly traffic volume in both directions divided by the number of days in the year

3.21

back slope

area proceeding from ditch bottom to the limit of the earthworks

3.22

bridge

structure erected for carrying a road over a river or any other gap with a single span-length or sum of span lengths of 4.0 m or more. Where the clear span is less than four metres, the structure is a culvert

3.23

carriageway

part of the road constructed for use by moving traffic, including auxiliary lanes, climbing lanes, and passing places but excluding shoulders

3.24

travelled way

That part of the carriageway used for the movement of vehicles, exclusive of auxiliary lanes, bus-bays and shoulders.

3.25

circular curve

usual curve configuration used for horizontal curves

3.26

clear zone

unencumbered roadside recovery area

3.27

compound curve

curve consisting of two or more arcs of different radii curving in the same direction and having a common tangent or transition curve where they meet

3.28

cross-fall/ chamber

tilt or transverse inclination of the cross-section of a carriageway, expressed as a percentage

3.29

cross-section

vertical section of the road at right angles to the centre line

3.30

deflection angle

successive angles from a tangent subtending a chord and used in setting out curves

3.31

design traffic volume

number of vehicles or persons that pass over a given section of a lane or carriageway during a time period of one hour or more

3.32

design volume

volume determined for use in design, representing traffic expected to use the road

3.33

embankment

portion of the road prism composed of approved fill material, which lies above the original ground and is bounded by the side slopes, extending downwards and outwards from the outer shoulder breakpoints and on which the pavement is constructed

3.34

road function

objective of providing a particular road link in terms of being "national", "districts or "access"

3.35

horizontal curve/curvature

curve/succession of curves, normally circular, in plan

3.36

transition curve

curve in which the radius changes continuously along its length, used for the purpose of connecting a straight with a circular curve, or two circular curves of different radii

3.37

vertical curve

curve on the longitudinal profile of a road,

3.38

vertical alignment

direction and course of the centre line in profile

3.39**gradient**

rate of rise or fall on any length of road, with respect to the horizontal. It is usually expressed as a percentage of vertical rise or fall in meters, 100 m of horizontal distance

3.40**horizontal alignment**

direction and course of the road centreline in plan

3.41**horizontal curve**

curve in plan

3.42**object height**

assumed height of a notional object on the surface of the roadway used for the purpose of determining sight distance

3.43**Passenger Car Equivalent Unit (PCU)**

unit of road traffic, equivalent for capacity purposes to one normal private car which is thus the unit and other vehicles are converted to the same unit by a factor depending on their type and circumstances

3.44**passing sight distance**

minimum sight distance on two-way single roadway roads that shall be available to enable the driver of one vehicle to pass another vehicle safely and comfortably without interfering with the speed of an oncoming vehicle travelling at the design speed, should it come into view after the overtaking manoeuvre is started

3.45**pavement**

part of a road designed to withstand the weight or loading by traffic

3.46**reaction time**

time taken by the driver to perceive the hazard ahead plus the time taken to activate the brake

3.47**shoulder**

That part of the verge adjacent to the carriageway designed to provide a safe stopping area in an emergency, a travel path for pedestrians and cyclists (where there is no other facility for them) and lateral support for the road pavement.

3.48**side slope**

area between the outer edge of shoulder or hinge point and the ditch bottom

3.49**sight distance**

distance visible to the driver of a passenger car measured along the normal travel path of a roadway to the roadway surface or to a specified height above the roadway surface, when the view is unobstructed by traffic

3.50**single lane road**

road consisting of a single traffic lane serving both directions, with passing bays

3.51**speed**

rate of movement of vehicular traffic or of specified components of traffic, expressed in kilometres per hour (km/h)

3.52**road hump**

physical obstruction, placed transversely on the surface of the carriageway for the purpose of reducing traffic speed

3.53**super elevation**

inward tilt or transverse inclination given to the cross section of a roadway throughout the length of a horizontal curve to reduce the effects of centrifugal force on a moving vehicle; expressed as a percentage

3.54**functional classification**

grouping of streets and roads according to the character of the service they are intended to provide

3.55**design hourly volume**

projected hourly volume that is used in the design

3.54**roadway**

portion of a road, including shoulders, intended for vehicular use

3.57**stopping sight distance**

distance required by a driver of a vehicle travelling at a given speed, to bring his vehicle to a stop after an object on the roadway becomes visible. It includes the distance travelled during the perception and reaction times and the vehicle braking distance

3.58**street**

road which has become partly or wholly defined by buildings established along one or both frontages

3.59**tangent**

portion of a horizontal alignment of straight geometrics

3.60**traffic**

vehicles, pedestrians and animals travelling along a route

3.61**traffic flow**

number of vehicles or persons that pass a specific point in a stated time, in both directions unless otherwise stated

3.62**traffic volume**

number of vehicles or persons that pass over a given section of a lane or a roadway during a time period of one hour or more. Volume is usually expressed in one of the terms: average annual daily traffic (AADT), Average Daily Traffic (ADT) and hourly volume

3.63**road**

way for vehicles and for other types of traffic which may or may not be lawfully usable by all traffic

3.64

street

road which has become partly or wholly defined by buildings established along one or both frontages

3.65

highway

a main road, especially one connecting major towns or cities

3.66

Decision Sight Distance (DSD)

The decision sight distance is the distance needed for a driver to detect an unexpected or otherwise difficult to-perceive information source or condition in a roadway environment that may be cluttered, recognize the condition or its potential threat, select an appropriate speed and path and initiate a complex manoeuvre

4 Symbols and/or abbreviated terms

DHV Design Hourly Volume

ADT Annual Daily Traffic

NMT Non-Motorised Traffic

AADT Average Annual Daily Traffic

SSD Stopping Sight Distance

PSD Passing Sight Distance

PCU Passenger Car Units

AASHTO American Association of State Highway and Transportation Officials

CF Cross Fall

DSD Decision Sight Distance

DTV Design Traffic Volume

ESALs Equivalent Single Axle Loads

LCVC Length of the Crest Vertical Curve

NCF Normal Cross Fall

PCU Passenger Car Equivalent Unit

ROW Right-Of-Way

SS Side Slopes

SW shoulder Width

TEF Traffic load Equivalent Factor

VPD Vehicle Per Day

LOS Level Of Service

- f side friction
- e super elevation

5 Road classification, access control and road reserve

5.1 Road classification and access control

5.1.1 For the purpose of design, roads design classes shall be Class 1, Class 2, Class 3, Class 4 and Class 5 (see Table 1), which are further classified into functional categories according to the character of the services they intend to provide

5.1.2 The major considerations in classifying highways and streets functionally are mobility and access. The extent and degree of access control is thus a significant factor in defining the functional class of highway and streets. Based on function, roads are broadly classified as:

- a) **mobility road:** that are intended to provide the highest level of mobility and the highest speeds over the longest uninterrupted distance. For mobility, high or continued speeds are desirable and variable or low speeds undesirable.
- b) **access roads:** that are intended to provide limited mobility and are the primary access to residential areas, businesses, farms, and other local areas. For access roads, low speeds are desirable and high speeds undesirable.

5.1.3 Roads may be designed to provide both mobility and accessibility and this leads to further classification of roads based on function as:

- a) **arterial roads:** with full or partial access control. which are intended to provide for high levels of safety and efficiency in the movement of large volumes of traffic at high speeds and therefore require a regulated limitation of access to enhance their primary function of mobility. Access to and egress from these facilities is permitted only at controlled locations such as an entrance and exit ramps. The access or egress may also be permitted directly from or to abutting land or via a limited number of at-grade intersections
- b) **collector roads:** that provide less mobility and therefore balance both functions of mobility and accessibility, combines aspects of both arterials and local streets. They collect traffic for movement between arterial streets and local roads and provide access to abutting land, and;
- c) **access roads:** that are intended to provide a limited mobility and are the primary access to residential areas, businesses, farms, or other abutting properties with unrestricted accessibility.

The road functional and design class, their conventional names and access control shall be as per Table 1.

Table 1 — Road classification and access control

Function	Design Class	Name conventions		Minimum Intersection Spacing	Access control
Mobility roads	Class 1	International trunk roads National trunk road	Principal Arterial/ Freeway/ Expressway	2500 m	Full

	Class 2	National roads Provincial roads Regional roads District roads	Major arterial/Highway	800 spacing	Full or partial
	Class 3	Regional roads District roads Secondary roads	Minor arterial/Collector	600 m	Full or partial
Access roads	Class 4	District roads Secondary roads	Collector roads	50 m	Partial
	Class 5	Minor roads Local streets	Local streets	15 m	Unrestricted

5.2 Road reserve dimensions and demarcation

5.2.1 The width of road reserve for each functional design class shall be as per Table 2 and shall be measured at right angle to the centreline of the median as illustrated in Figure 1a and Figure 1b.

5.2.2 The road reserve shall be demarcated by two parallel lines at required distance from the centreline of the median as illustrated in Figure 1a.

5.2.3 The road reserve for city roads in the cities and for specific roads may be determined in accordance with the applicable city master plan or depending on the intended use of the specific roads.

Table 2 — Width of road reserve

Design Class	Name conventions		Minimum road reserve (m)
Class 1	International trunk roads National trunk road	Principal Arterial/ Freeway/ Expressway	50 -
Class 2	National roads Provincial roads Regional roads District roads	Major arterial/Highway	44
Class 3	Regional roads District roads Secondary roads	Minor arterial/Collector	24
Class 4	District roads Secondary roads	Collector roads	24
Class 5	Minor roads Local streets	Local streets	10

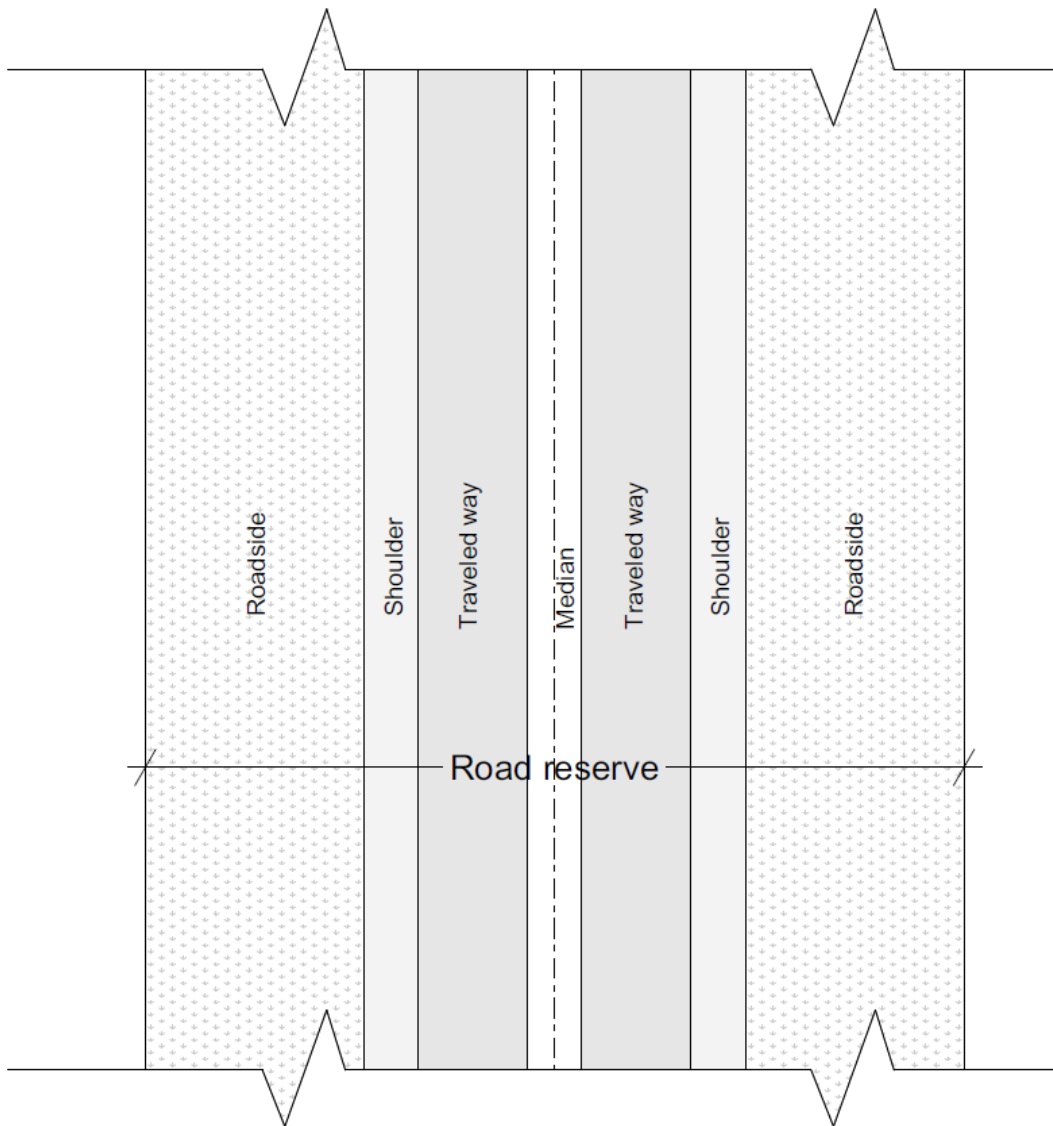

Figure 1a — Plan view of roadway illustrating road reserve

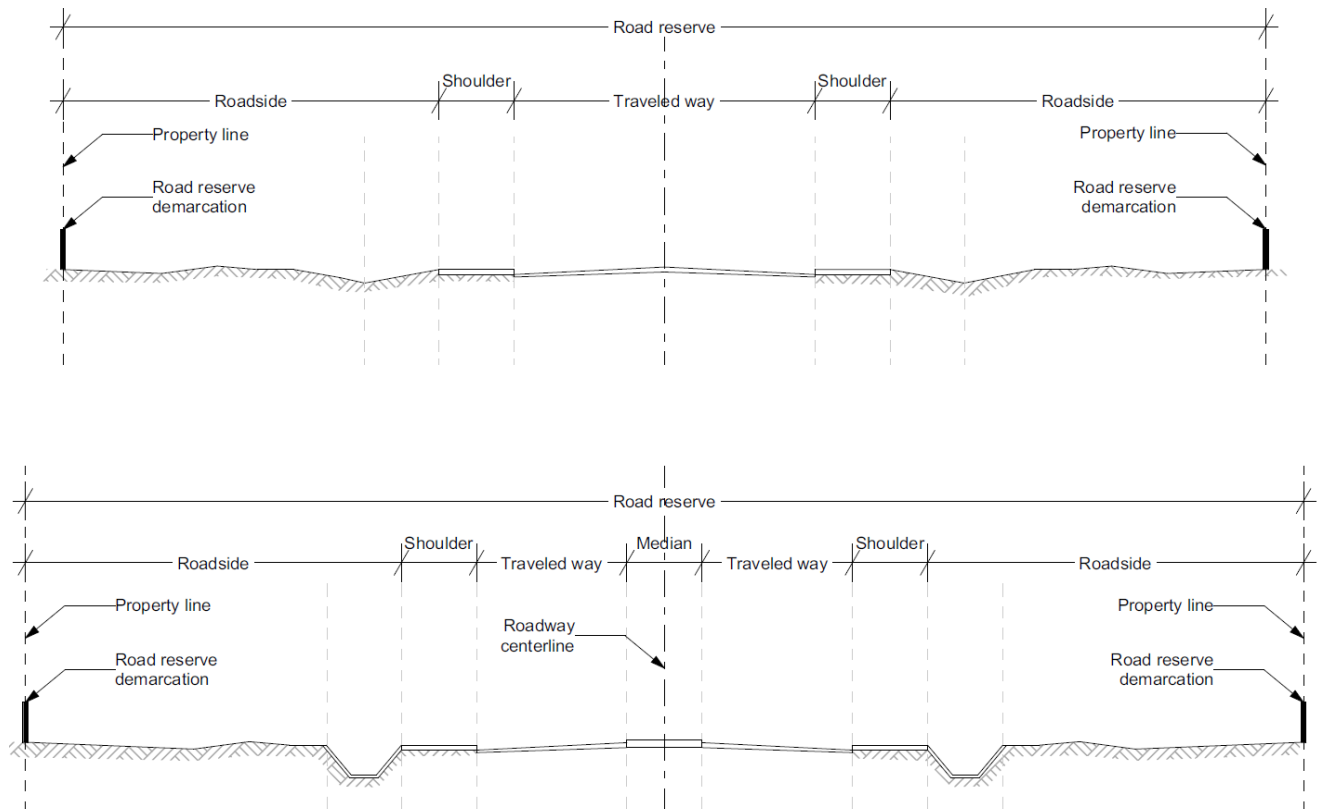

Figure 1b — Typical section illustrating the road reserve

6 Design control and criteria

6.1 Design Vehicle and Vehicle Characteristics

The physical characteristics and proportions of vehicle of various sizes using highway are key control in geometrical design of highway. The design vehicle representative characteristics and operating characteristics that are used to establish highway design controls for accommodating vehicles of the designated classes.

Three general classes of design vehicles covered by this standard are:

1. **Passenger cars class**, which include passenger cars of all sizes, sport or utility vehicles, minivans, vans and pickup trucks.
2. **Buses class**; which includes intercity, city transit, school and articulated buses.
3. **Trucks class**; includes single-unit trucks, truck tractor-semitrailer combinations and trucks with semitrailers in combination with full trailers.

Dimensions for design vehicles representing vehicles within these three general classes are given in Table 3.

NOTE 1 for the purpose of geometrical design, each design vehicle has larger physical dimensions and larger minimum turning radius than most vehicle in its class. The larger design vehicles are usually accommodated in highway design.

NOTE 2 The dimensions used to define design vehicles are not averages or maxima, nor are they legal limiting dimensions. They are, in fact, typically the 85th percentile or 15th percentile value of any given dimension. The design vehicles are therefore hypothetical vehicles, selected to represent a particular vehicle class.

Table 3 — Design vehicle dimensions

Design vehicle type	Symbol	Dimension (m)				
		Length	width	Height	Minimum design turning radius	Wheelbase
Passenger cars						
Passenger car	DV1	5.8	2.1	1.3	7.31	3.35
Buses						
Single unit bus	DV2	12.1	2.6	4.1	12.8	7.6
Articulated bus	DV3	18.3	2.6	3.4	12.1	6.7 + 5.9
Trucks						
Single unit truck	DV4	9.1	2.6	4.6	12.8	6.1
Semi-trailer	DV5	18.2	2.6	4.6	12.65	5.5+10.0
Rigid truck and drawbar trailer combination	DV6	22.0	2.6	4.6	12.0	4.6+8.2
Interlink (with a short truck tractor)	DV7	22.0	2.6	4.6	12.0	4.1+6.52 ^a +7.94
Semi-trailer with long trailer	DV8	21.0	2.6	4.6	13.7	6.1 & 12.8
^a distance between SU rear wheels and trailer front wheels						

6.2 Terrain

6.2.1 The terrain category is an important factor that affects roadway geometric design. It affects the general constructional requirements, cost of construction driving safety and design speed.

6.2.2 For the purpose of design, the terrain to be considered for geometrical design of highways and streets shall be flat, rolling, mountainous and steep, depending on the range of prevailing cross slope/transversal Slope as given in Table 4.

Table 4 — Design terrain Category

Terrain Category	Cross slope/Transversal Slope
Flat	0% - 10%
Rolling	10% to 25%
Mountainous	25% to 60%

Steep	More than 60%
-------	---------------

6.3 Driver Performance

6.3.1 The driver's performance such as perception-reaction time, height of driver's eye, and object height are important controls to be considered for the geometrical design of highways.

6.3.2 The **Perception-Reaction** time which is the time required for the driver to process information after detecting and recognising a given situation shall be taken as 2.5 seconds.

6.3.3 The recommended value for the height of Driver's Eye shall be 1.05 m above the roadway surface.

6.3.4 The height of the object that might appear as a threat to the driver is considered for computation of the required sight distance. The recommended values for vertical height for stopping sight distance, decision sight distance, passing sight distance shall be as per Table 5.

Table 5 — Object height values

Object height (m)		
Stopping sight distance	Decision sight distance	Passing sight distance
0.60	0.60	1.08

6.4 Pedestrians and Cyclists Performance

6.4.1 For the design of Non-Motorised Transport (NMT) facilities, the pedestrian and cyclists performance considered are pedestrian speed and age, bicycle speed, coefficient of friction for braking, minimum height, and width for bicycle operation.

6.4.2 The designer shall consider the speed of 1.2 m/s. Where complex elements such as channelization and separate turning lanes are featured, it is recommended that the designer should assess alternatives that will assist older pedestrians. Pedestrian safety can be enhanced by the provision of median refuge islands of sufficient width at wide intersections, and lighting at locations that demand multiple information gathering and processing.

6.4.3 The typical bicycle performance criteria and operation characteristics shall be as per Table 6.

Table 6 — Bicycle operation characteristics

Bicycle speed (km/h)	Minimum height (m)	Width (m)	coefficient of friction for braking
13 - 24	1.0	1.5	0.32

6.5 Traffic Characteristics

6.5.1 Traffic Composition

6.5.1.1 It is not practical to design for a heterogeneous traffic stream and, for this reason; trucks and other types of vehicles are converted to equivalent Passenger Car Units (PCUs). The number of PCU's associated with a single vehicle type is a measure of the impedance that it offers to the passenger cars in the traffic stream. The number of equivalent passenger cars equalling the effect of one truck is dependent on the roadway gradient and, for two-lane highways, on the available passing sight distance.

Table 7 gives the recommended Passenger Car Units (PCUs) varying with the terrain category.

Table 7 — Passenger car equivalent factors

Vehicle type	Terrain		
	Flat	Rolling	Mountainous
	Pcu		
Passenger cars	1.0	1.0	1.5
Light goods vehicles	1.0	1.5	3.0
Medium goods vehicles	2.5	5.0	10.0
Heavy goods vehicles	3.5	8.0	20.0
Buses	2.0	4.0	6.0
Motor cycles, scooters	0.5	1.0	1.5
Pedal cycles	0.5	0.5	NA

6.5.2 Projection of Future Demands

The projection of future traffic demand should be based on a period of 20 years while designing for new roadway and for reconstruction, 10 years for rehabilitation and upgrade.

6.5.2 Design Hourly Volume (DHV)

6.5.2.1 The design hourly volume is estimated as follows:

$$DHV = AADT \times K \text{ or } DHV = ADT \times K$$

Where,

DHV is Design Hourly Volume

AADT is Average Annual Daily Traffic

ADT is Annual Daily Traffic

K is a factor estimated from the ratio of the 30th HV to the AADT from a similar site

6.5.2.2 The shall be used to estimate K factors for estimation of DHV and in the absence of such factors the 30th-highest DHV can be estimated by applying 0.15 and 0.10 to ADT for rural highways and urban roads, respectively.

6.6 Design Speed

Design speed is a selected speed used to determine the various geometric design features of the roadway such as curvature, super elevation, and sight distance. The assumed design speed is usually expected to be a logical one with respect to the terrain, anticipated operating speed, the adjacent land use, and the functional classification of highway.

Table 8 gives the values of design speed based on the classes of highway and the terrain category.

Table 8 — Design speed

Road class		Design Speed (km/h)			
		Flat terrain	Rolling terrain	Mountainous	Steep
Mobility roads	Class 1	120	100	60	60
	Class 2	110	80	50	50
	Class 3	100	80	50	40
Access roads	Class 4	80	60	40	40
	Class 5	60	40	30	30

NOTE Except for local streets where speed controls are frequently included intentionally, it is advised to use as high a design speed as practical to attain a desired degree of safety, mobility, and efficient within the constraints of environmentally quality, economics, aesthetics, and social or political impacts. Also, above-minimum design values should be used, where practical.

6.7 Levels of Service

6.7.1 The quality of traffic service provided by specific road facility under specific traffic demands shall be defined by means of Levels Of Service (LOS). There are six level of service ranging from level A which is the free flow condition, where drivers can maintain their desired speed (low volume and high speed); to level of service F which is the forced flow condition (most congested) where the traffic density is the maximum with drivers subjected to frequent stop-go and queues. There should be six LOS:

- A. **Free flow:** traffic flows at or above the posted speed limit and motorists have complete mobility between lanes. The average spacing between vehicles should be about twenty-seven-car lengths. Motorists have a high level of physical and psychological comfort. The effects of incidents or point breakdowns are easily absorbed.
- B. **Reasonably free flow:** LOS A speeds shall be maintained, manoeuvrability within the traffic stream should be slightly restricted. The lowest average vehicle spacing should be about sixteen-car lengths. Motorists still have a high level of physical and psychological comfort.
- C. **Stable flow at or near free flow:** Ability to manoeuvre through lanes should be noticeably restricted and lane changes shall require more driver awareness. Minimum vehicle spacing should be about eleven-car lengths. Minor accidents may still have no effect but localized service may have noticeable effects and traffic delays may form behind the accident. This should be the target LOS for some urban and most rural roads.
- D. **Approaching unstable flow:** Speeds slightly decrease as traffic volume slightly increases. Freedom to manoeuvre within the traffic stream shall be limited and driver comfort levels decrease. Vehicles should be spaced about eight-car lengths apart. Level D should be a common goal for urban streets during peak hours, as attaining LOS C would require prohibitive costs and social impact via bypass roads and lane additions.
- E. **Unstable flow:** operating at capacity: Flow becomes irregular and speed varies rapidly because there are virtually no usable gaps to manoeuvre in the traffic stream and speeds rarely reach the posted limit. Vehicle spacing should be about six-car lengths. Any disruption to traffic flow, such as merging ramp traffic or lane changes, can create a shock wave affecting downstream traffic. Any incident can create serious delays. The drivers' level of comfort becomes poor.
- F. **Forced or breakdown flow:** Every vehicle moves in lockstep with the vehicle in front of it, with frequent slowing required. Travel time should not be predicted, with generally more demand capacity.

The choice of level of service shall generally be based on economic considerations. Table 9 gives the guidelines for selection of level of service depending on the class of road being designed and the category of terrain.

Table 9 — Guidelines for selection of design levels of service

Level of service for specified combinations of terrain and area type					
Function	Class	Flat terrain	Rolling terrain	Mountainous terrain	Steep terrain
Mobility roads	Class 1	B	B	C	C
	Class 2	B	C	D	D
	Class 3	C	C	D	D
Access roads	Class 4	D	D	D	D
	Class 5	D	D	D	D

6.7.2 The maximum volume that can be carried at any selected level of service is referred to as the service volume for that level. The traffic flow rates that can be served at each level of service are termed as service flow rate.

6.7.2 Once a level of service has been identified as applicable for design, the accompanying service flow rate logically become the design service flow rate, implying that if the traffic flow rate using the facility exceeds that value, operating conditions will fall below the level of service for which the facility was designed.

6.8 Access Control and Access Management

6.8.1 Partner states should put in place statutes, land-use ordinances, geometric design policies, and driveway regulations for managing and controlling access

6.8.2 The principal advantages of controlling access are the preservation or improvement of service and the reduction of crash frequency and severity. The proper access control and access management is usually achieved through a number of controls which can be categorized as follow:

- a) **full control of access**, which means that preference is given to through traffic by providing access connections by means of ramps with only selected public roads and by prohibiting crossings at grade and direct private driveway connections.
- b) **partial control of access**, some preference should be given to through traffic. Access connections, which may be at-grade or grade-separated, are provided with selected public roads and private driveways
- c) **access management**, that involves providing (or managing) access to land development while simultaneously preserving the flow of traffic on the surrounding road system in terms of capacity, speed, and low crash frequency and severity. Access management applies to all types of roads and streets. It calls for setting access policies for various types of roadways, keying designs to these policies, having the access policies incorporated into legislation, and having the legislation upheld in the courts.
- d) **driveway/entrance regulations**, may be applied even though no control of access is obtained. Each abutting property is permitted access to the street or highway; however, the location, number, and geometric design of the access points are governed by the regulations

6.8.3 The extent of access management depends upon the location, type, and density of development, and the nature of the highway system. Access management actions involve both the planning and design of new roads and the retrofitting of existing roads and driveways. The following principles define access management techniques.

- a. Classify the road system by the primary function of each roadway. traffic movement.

- b. Limit direct access to roads with higher functional classifications.
- c. Locate traffic signals to emphasize through traffic movements.
- d. Locate driveways and major entrances to minimize interference with traffic operations.
- e. Use curbed medians and locate median openings to manage access movements and minimize conflicts.

6.8.4 Access can be managed and controlled by means of statutes or transport agency, land-use ordinances, geometric design policies, and driveway regulations. Key elements of access management include

- a) defining the allowable access and access spacing for various classes of highways,
- b) providing a mechanism for granting variances when reasonable access cannot otherwise be provided, and
- c) establishing means of enforcing policies and decisions.

These key elements, along with appropriate design policies, should be implemented through a legal code that provides a systematic and supportable basis for making access decisions.

7 Design elements

7.1 Sight distances

7.1.1 Stopping Sight Distance (SSD)

7.1.1.1 The road shall be designed to have adequate stopping sight distance (SSD) to allow a driver to see objects in the road with sufficient time to manoeuvre around them or to stop.

7.1.1.2 The stopping sight distance (SSD) is given by the formula below, and the typical design values corresponding to different design speed are given Table 10.

$$SSD = 0.278Vt + 0.039 \frac{V^2}{a}$$

where

SSD is Stopping Sight Distance

V is Design speed, km/h

t is Brake reaction time, 2.5 sec

a is Deceleration rate, m/s²

Table 10 — Stopping site distance on level road

Design	Brake reaction	Braking distance	Stopping sight distance (m)
---------------	-----------------------	-------------------------	------------------------------------

speed (km/h)	distance (m)	on level (m)	Calculated (m)	Design (m)
20	13.9	4.6	18.5	20
30	20.9	10.3	31.2	35
40	27.8	18.4	46.2	50
50	34.8	28.7	63.5	65
60	41.7	41.3	83.0	85
70	48.7	56.2	104.9	105
80	55.6	73.4	129.0	130
90	62.6	92.9	155.5	160
100	69.5	114.7	184.2	185
110	76.5	138.8	215.3	220
120	83.4	165.2	248.6	250
130	90.4	193.8	284.2	285

NOTE Brake reaction distance prediction on a time of 2.5s, deceleration rate of 3.4m/s used to determine calculated sight distance

7.1.1.3 The brake reaction time commonly considered as adequate for complex conditions as those of laboratory test should be 2.5 sec. The need for greater reaction time can be encountered in most complex situations such as those found at multiphase at grade intersections.

7.1.1.4 The approximate braking distance of a vehicle level roadway travelling at a design speed of the roadway may be determined from the following equation:

$$d_B = 0.039 \frac{V^2}{a}$$

where

d_B is braking distance, m;

V is design speed, km/h;

a is deceleration rate, m/s².

Note The braking distance shall be computed on base of the applicable design speed using a deceleration rate of 3.4 m/s² and a reaction time of 2.5 sec.

7.1.2 Passing Sight Distance (PSD)

7.1.2.1 Passing Sight Distance shall be the minimum sight distance on two-way single roadway roads that shall be available to enable the driver of one vehicle to pass another vehicle safely without interfering with the speed of an oncoming vehicle travelling at the design speed.

7.1.2.2 Within the sight area, the terrain should be the same level or a level lower than the roadway. Otherwise, for horizontal curves, it may be necessary to remove obstructions and widen cuttings on the insides of curves to obtain the required sight distance.

7.1.2.3 Care shall be taken in specifying passing/no-passing zones in areas where the sight distance may be obscured in the future due to vegetative growth.

7.1.2.4 Passing sight distance shall be measured between an eye height of 1.08 m and an object height of 1.08 m. The sight line near the centre of the area inside the curve should be approximately 0.24 m higher

than the stopping sight distance. In cut sections, the resultant lateral dimension for normal highway cross sections (1V:2H to 1V:6H back slopes) between the centreline of the inside lane and the midpoint of the sight line is from 0.5 m to 1.5 m greater than that for stopping sight distance.

7.1.2.5 The passing sight distance should be calculated on the basis of a distance required for a successful overtaking manoeuvre and makes adequate provision for an aborted manoeuvre in the case of a truck attempting to pass another truck. The minimum passing sight distance should be the total of four components: $d_1 + d_2 + d_3 + d_4$

where

d_1 is the distance travelled during the perception-reaction time and during initial acceleration to the point where the passing vehicle just enters the right lane;

d_2 is the distance travelled during the time passing vehicle is travelling in the right lane;

d_3 - distance between the passing vehicle and the opposing vehicle at the end of the passing manoeuvre;

d_4 is the distance moved by the opposing vehicle during two thirds of the time the passing vehicle is the left lane (usually taken to be $2/3 d_2$).

7.1.2.6 The recommended minimum passing sight distance for two lane-roads are given in Table 11.

Table 11 — Passing sight distance for design of two-lane highways

Design speed (km/h)	Assumed speeds(km/h)		Passing sight distance (m)	
	Passed vehicle	Passing vehicle	Total sight distance	Rounded for design
30	29	44	200	200
40	36	51	266	270
50	44	59	341	345
60	51	66	407	410
70	59	74	482	485
80	65	80	538	540
90	73	88	613	615
100	79	94	670	670
110	85	100	727	730
120	90	105	774	775
130	94	109	812	815

7.1.3 Decision Sight Distance (DSD)

Decision sight distance shall offer drivers additional margin for error, afford them sufficient length to manoeuvre their vehicles at the same reduced speed, other than to just stop, its values are substantially greater than stopping sight distances (See Table 12).

Table 12 — Decision Sight Distance

Design speed (km/h)	Decision Sight Distance (m)				
	Avoidance manoeuvre				
	1	2	3	4	5
50	70	155	145	170	195

60	95	195	170	205	235
70	115	325	200	235	275
80	140	280	230	270	315
90	170	325	270	315	360
100	200	370	315	355	400
110	235	420	330	380	430
120	265	470	360	415	470

NOTE 1 Avoidance manoeuvre A: Stop on rural road $-t = 3.0$ s;

NOTE 2 Avoidance manoeuvre B: Stop on urban road $-t = 9.1$ s;

NOTE 3 Avoidance manoeuvre C: Speed/path/direction change on rural road $10.2 \text{ s} < t < 11.2 \text{ s}$

NOTE 4 Avoidance manoeuvre D: Speed/path/direction change on rural road $12.1 \text{ s} < t < 12.9 \text{ s}$

NOTE 5 Avoidance manoeuvre E: Speed/path/direction change on rural road $14.0 \text{ s} < t < 14.5 \text{ s}$

NOTE 6 Avoidance manoeuvres A and B are given by the following relationship:

$$DSD = 0.278Vt + 0.039 \frac{V^2}{a}$$

where

DSD is Decision Sight Distance, m

t is pre-manoeuve time, sec

V is design speed, km/h

a is driver deceleration, m/s^2

NOTE 7 Avoidance manoeuvres C, D and E are given by the following relationship:

$$DSD = 0.278Vt$$

where

DSD is Decision Sight Distance, m

t is total pre-manoeuve and manoeuvre time, sec

V is design speed, km/h

7.2 Horizontal alignment

7.2.1 Alignment between control points

Alignment between control points should be designed to be as favourable as practical, consistent with the environmental impact, topography, terrain, design traffic volume, and the amount of reasonably obtainable right-of-way. Sudden changes between curves of widely different radii or between tangents and sharp curves should be avoided. Where crest vertical curves and horizontal curves occur together, greater than minimum sight distance should be provided so that the horizontal curves are visible to approaching drivers. The following basic curve formula for moving mass on a curve features the relationship between the side friction, the rate of roadway superelevation, the radius of curve and the design.

$$\frac{0.01e + f}{1 - 0.01ef} = \frac{v^2}{gR} = \frac{0.0079V^2}{R} = \frac{V^2}{127R}$$

where

e is rate of roadway superelevation, per cent;

f is side friction (demand) factor;

v is vehicle speed, m/s;

g is gravitational constant, 9.81 m/s²;

V is vehicle speed, km/h;

R is radius of curve, measured to a vehicle's centre of gravity, m.

NOTE: For unpaved roads, the range depends on the type of terrain

7.2.2 The straight

Long straight shall be avoided as it increases the danger from headlight glare and usually lead to excessive speeding. In hot climate areas, long tangents have been shown to increase driver fatigue and hence cause accidents.

The straight section shall not have length greater than $20 \times V_D$ (where V_D is design speed in km/h, and a minimum length of $6 \times V_D$ m should also be adopted between circular curves following the same direction.

7.2.3 Minimum Radius of Horizontal Curve

7.2.3.1 The minimum radius of horizontal curve design, for a given design speed, shall be limited by maximum allowable side friction (f_{max}), which is usually based on comfort standard, maximum super elevation rate (e_{max}) and the necessity to maintain stopping sight distance.

7.2.3.2 For a given speed, minimum curve radius is limited by maximum allowable side friction, which is usually based on comfort required, maximum super-elevation rate for the curve, and the necessity to maintain stopping sight distance. The minimum radius can be calculated directly from the simplified curve equation as:

$$R_{min} = \frac{v^2}{127(0.01e_{max} + f_{max})}$$

where

R_{min} minimum radius of horizontal curve

f_{max} maximum allowable side friction

e_{max} maximum super elevation

7.2.3.3 Maximum superelevation rates shall be controlled by such factors as climate conditions (frequency and amount of rain); terrain conditions (flat, rolling or mountainous); type of area (rural, urban); and frequency of slow-moving vehicles whose operation might be affected by high superelevation rates. The maximum super elevation for roads in urban roads shall be 4% and 10% on roads in the rural areas.

7.2.3.4 The maximum side friction factors corresponding to the given design speed shall be as per the Table 13.

Table 13 — Side friction factors for different design speeds

Design Speed (km/h)	Maximum super	Limiting values of side friction	Total side friction	Calculated radius (m)	Rounded radius (m)
---------------------	---------------	----------------------------------	---------------------	-----------------------	--------------------

	elevation e (%)	(f)	(e/100 + f)		
50	4	0.16	0.20	98.4	100
60	4	0.15	0.19	149.2	150
70	4	0.14	0.18	214.3	215
80	4	0.14	0.18	280.0	280
90	4	0.13	0.17	375.2	375
100	4	0.12	0.16	492.1	490
110	4	0.11	0.15	635.2	635
120	4	0.09	0.13	872.2	870
50	6	0.16	0.22	89.47745	90
60	6	0.15	0.21	134.9831	135
70	6	0.14	0.2	192.9134	195
80	6	0.14	0.2	251.9685	250
90	6	0.13	0.19	335.6817	335
100	6	0.12	0.18	437.4453	435
110	6	0.11	0.17	560.4447	560
120	6	0.09	0.15	755.9055	755
50	8	0.16	0.24	82.021	80
60	8	0.15	0.23	123.2455	125
70	8	0.14	0.22	175.3758	175
80	8	0.14	0.22	229.0623	230
90	8	0.13	0.21	303.712	305
100	8	0.12	0.2	393.7008	395
110	8	0.11	0.19	501.4505	500
120	8	0.09	0.17	666.9755	665
50	10	0.16	0.26	75.71169	75
60	10	0.15	0.25	113.3858	115
70	10	0.14	0.24	160.7612	160
80	10	0.14	0.24	209.9738	210
90	10	0.13	0.23	277.3023	275
100	10	0.12	0.22	357.9098	360
110	10	0.11	0.21	453.6933	455
120	10	0.09	0.19	596.7675	595
50	12	0.16	0.28	70.30371	70
60	12	0.15	0.27	104.9869	105
70	12	0.14	0.26	148.3949	150
80	12	0.14	0.26	193.8219	195
90	12	0.13	0.25	255.1181	255
100	12	0.12	0.24	328.084	330
110	12	0.11	0.23	414.2417	415
120	12	0.09	0.21	539.9325	540

--	--	--	--	--	--

7.2.4 Minimum and maximum lengths of curve

For small deflection angles, it is required that curves shall be long enough to avoid the appearance of a kink. On the other hand, a long curve, particularly if it is of near-minimum radius, may causes tracking problems.

The maximum length of curve shall not exceed 1000 m while the minimum length shall not be less than 300 m.

7.2.5 Transition curve

7.2.5.1 A transition curve shall be provided to give the driver a natural path that is easy to follow as a vehicle enters or leaves a circular horizontal curve and at the same time provides a suitable arrangement for affecting the super elevation runoff.

7.2.5.2 The minimum length of transition curve shall be defined based on consideration of driver comfort and shifts in the lateral position of vehicles and these two criteria are used together to determine the minimum length of spiral which can be computed as follow:

$$L_{s,\min} = \sqrt{24(p_{\min})}R \text{ or } L_{s,\min} = 0.0214 \frac{V^3}{RC}$$

Where:

$L_{s,\min}$ minimum length of spiral, m

p_{\min} minimum lateral offset between the tangent and circular curve (0.20 m)

R radius of circular curve, m

V design speed, km/h

C maximum rate of change in lateral acceleration (1.2 m/s³)

7.2.5.3 The maximum relative gradient between pavement edges as given in Table 14 will determine the minimum length for the runout and runoff and hence the minimum length of the transition curves.

Table 14 — Maximum relative gradient

Design Speed (km/h)	30	40	50	60	80	100	110	120
Maximum relative gradient	1:133	1:143	1:154	1:167	1:200	1:227	1:244	1:263

7.2.5.4 The length of spiral transition curve shall not be so long (relative to the length of the circular curve) that drivers are misled about the sharpness of the approaching curve. A conservative maximum length of spiral that can minimize the likelihood of such concerns can be computed as:

$$L_{s,\max} = \sqrt{24(p_{\max})}R$$

Where:

$L_{s,\max}$ maximum length of spiral, m

p_{\max} minimum lateral offset between the tangent and circular curve (1.0 m)

R radius of circular curve, m

7.2.5.5 The desirable lengths of spiral transition curves for street and highway design, that correspond to 2.0 s of travel time at the design speed of the roadway are shown in Table 15.

Table 15 — Desirable length of spiral curve transition

Design speed (km/h)	20	30	40	50	60	70	80	90	100	110	120	130
Spiral length (m)	11	17	22	28	33	39	44	50	56	61	67	72

7.2.5.5 The use of longer spiral curve lengths that are less than $L_{s,max}$ than is acceptable. However, where such longer spiral curve lengths are used, consideration should be given to increasing the width of the travelled way on the curve to minimize the potential for encroachments into adjacent lanes. Further, if the desirable spiral curve length shown in Table 15 is less than the minimum spiral curve length $L_{s,min}$, the minimum spiral curve length should be used in design.

7.2.5.6 For the various design speeds, a radius corresponding to a specified centripetal acceleration can be calculated. Thus, a changing radius at a specific speed corresponds to a specific rate of change of centripetal acceleration. For comfort, the range varies between 0.4 and 1.3 m/s². If the radius of the circular curve is less than the values shown in Table 5-8, then transition curves are required to achieve this degree of comfort. For curves of large radius, the rate of change of lateral acceleration is small and transition curves are not normally required. Transition curves are also unnecessary for roads of low design speeds or low classification.

7.2.5.7 The typical transition curve is illustrated in Figure 2 and requirements for transition curve are given in Table 16

Table 16 — Transition curve requirements

Design Speed (km/h)	Transition required if radius of curve is less than:
70	290
80	380
85	428
90	480
100	590
110	720
120	850

Table 5-8: Transition curve requirements (m)

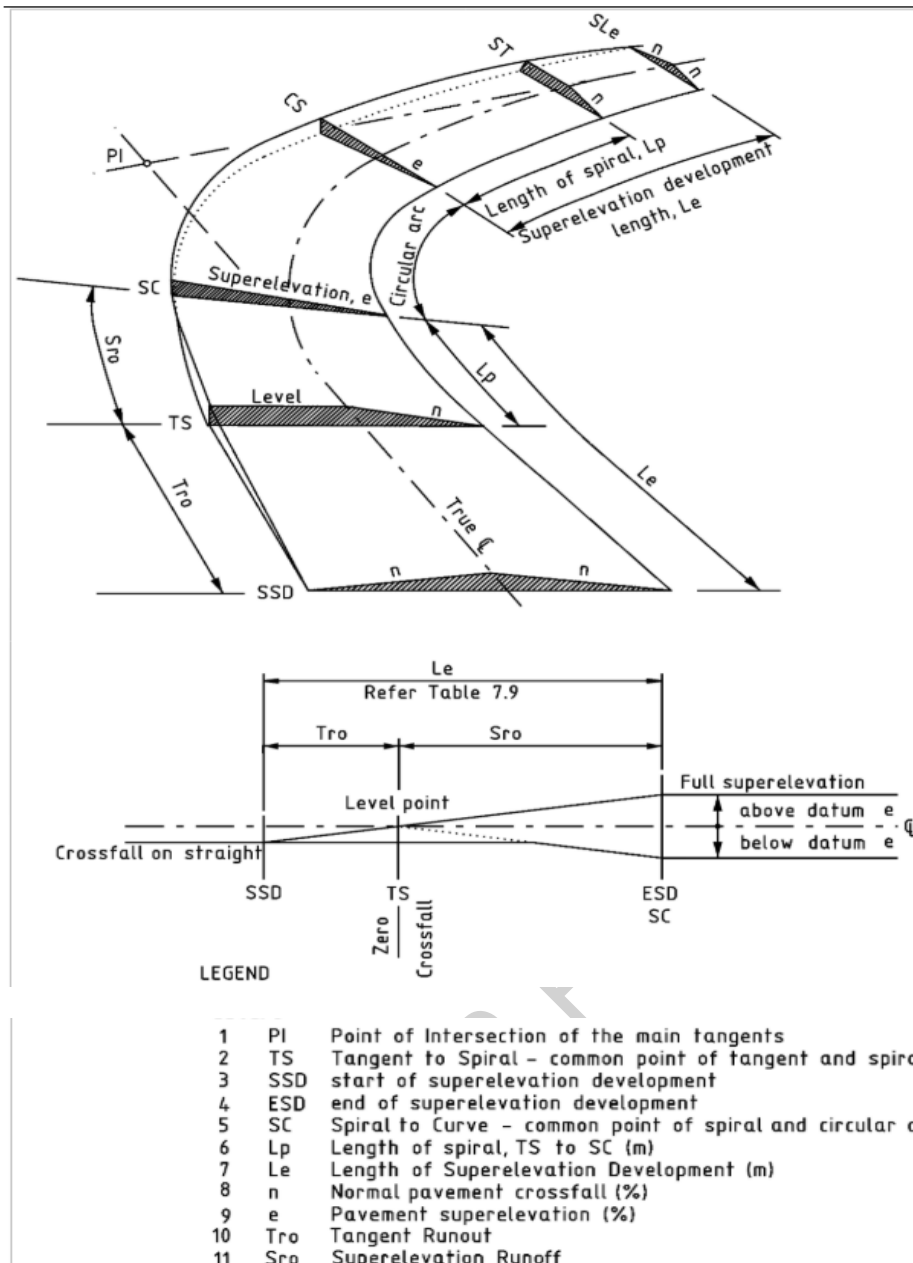

Figure 2 — Elements of Super-elevation and transition curve

7.2.5.8 Generally, the Euler spiral, which is also known as the clothoid, is used in the design of transition curves. The radius of curvature at a point on a curve is the radius of the circle that fits the curve at that point. It is calculated from:

$$R = \frac{[1 + (\frac{dy}{dx})^2]^{3/2}}{\frac{d^2y}{dx^2}}$$

The equation for the applicable clothoid transition curve is:

$$A^2 = R.L$$

Where,

A the clothoid parameter,

R the radius at the end of the clothoid,

L the length of the clothoid.

7.2.5.9 The radius (R) varies from infinity at the straight end of the spiral to the radius of the circular arc at the end of the transition. The clothoid parameter, A, expresses the rate of change of curvature along the clothoid. Large values of A represent slow rates of change of curvature while small values of A represent rapid rates of change of curvature. The most rapid rate of change of curvature is represented by the minimum permissible value of A_{min} . The determination of A_{min} is based upon considerations of the rate of change of centrifugal acceleration, super-elevation run-off, aesthetics, and the ratio of the radii of consecutive curves of a compound curve as described below: -

$$A_{min} = 0.21(VD)^{1.5}$$

Where,

VD = Design Speed (km/h)

The clothoid must have sufficient length to accommodate the super-elevation run-off That is:

$$A_{min} = (R \cdot L_{min})^{0.5}$$

and for aesthetic reasons the shape of the curve should be clearly visible therefore

$$A_{min} = R/3$$

Finally, the two branches of the clothoid (at either end of the tangent section) should have approximately the same parameters that would therefore produce a similar rate of change of curvature.

7.2.6 Reverse Curves, Broken-back Curves, and Compound Curves

7.2.6.1 Reverse curve

This is a curve followed by another curve in the opposite direction (see Figure 3) The occurrence of abrupt reverse curves (i.e., a short tangent between two curves in opposite directions) should be avoided. Such geometrics make it difficult for the driver to remain within the lane. It is also difficult to super-elevate both curves adequately, and this may result in erratic operation.

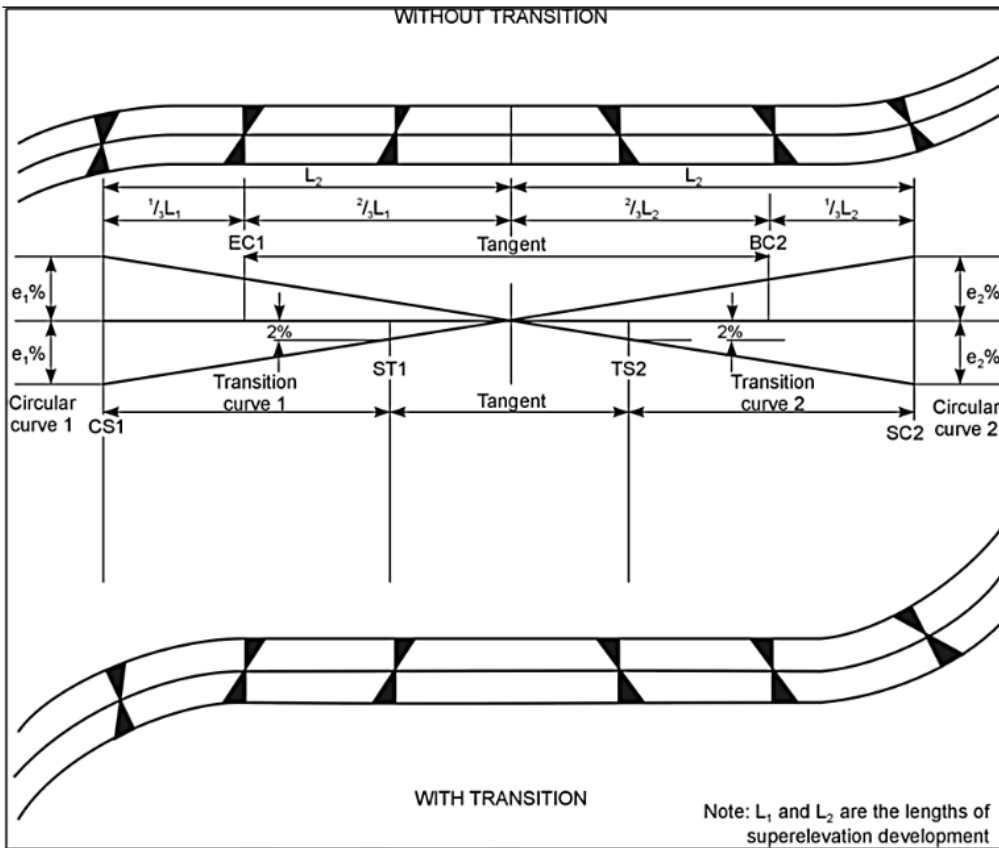

Figure 3 — Super-elevation of Reverse Curves

7.2.6.2 Broken-back curve

This is a curve followed by another curve in the same direction but with only a short tangent in between. Broken-back curves should be avoided except where very unusual topographical or right-of-way conditions dictate otherwise. Drivers do not generally anticipate successive curves in the same direction hence safety is compromised. Problems with super-elevation and drainage can also arise. A single curve is preferred if it is physically and economically feasible. The super-elevation is illustrated in Figure 4.

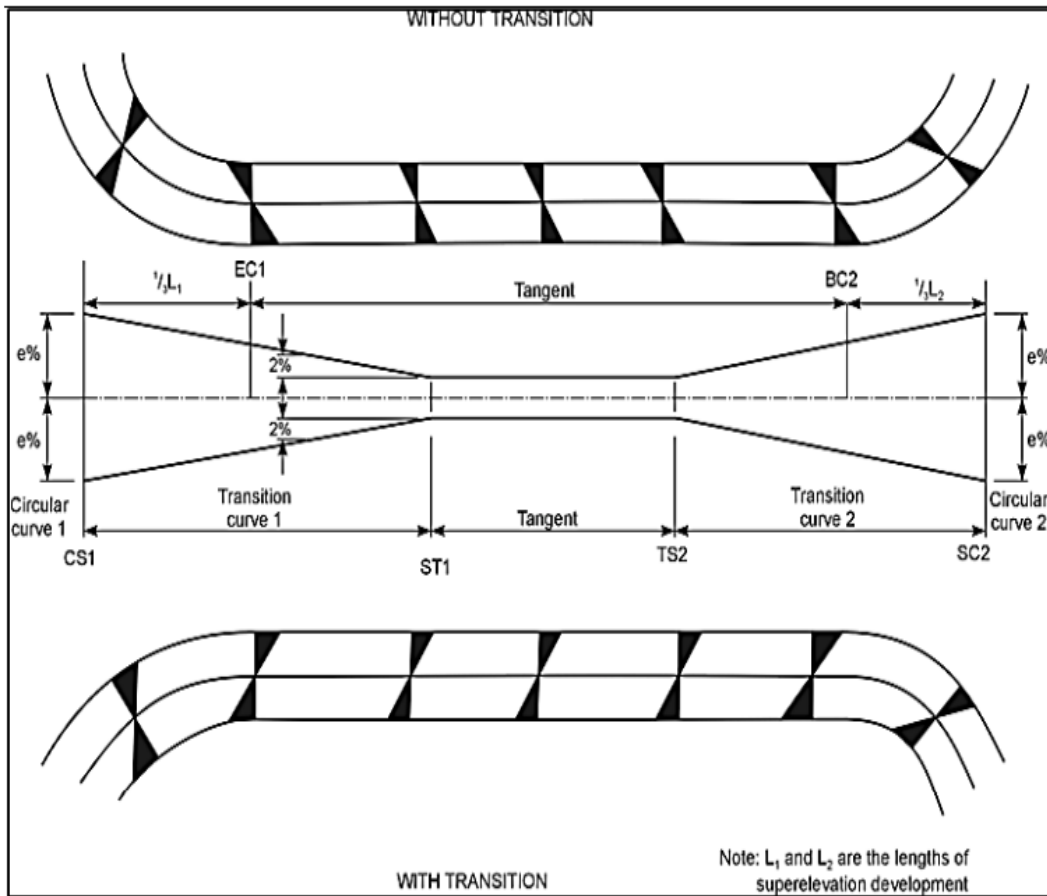

Figure 4 — Super-elevation of broken-back curve

7.2.6.3 Compound curve

Compound curves as illustrated in (see Figure 5) are curves in the same direction but of different radii, and without any intervening tangent section. The use of compound curves provides flexibility in fitting the road to the terrain and other controls. Caution should, however, be exercised in the use of compound curves because the driver does not expect to be confronted by a change in radius once a curve has been entered, hence safety is compromised. Their use should be avoided especially where the curves need to be of short radius.

If two successive circular curves in the same direction cannot be avoided, the connecting tangent should be at least 150 m long. The tangent should have a single cross fall rather than reverting to a normal camber for a short distance.

Compound curves with large differences in curvature introduce the same problems as are found at the transition from a tangent to a small-radius curve. Where the use of compound curves cannot be avoided, the radius of the flatter circular arc should not be more than 50 % greater than the radius of the sharper arc, i.e., R_1 should not exceed $1.5.R_2$. A compound arc on this basis is suitable as a form of transition from either a flat curve or a tangent to a sharper curve, although a spiral transition curve is preferred.

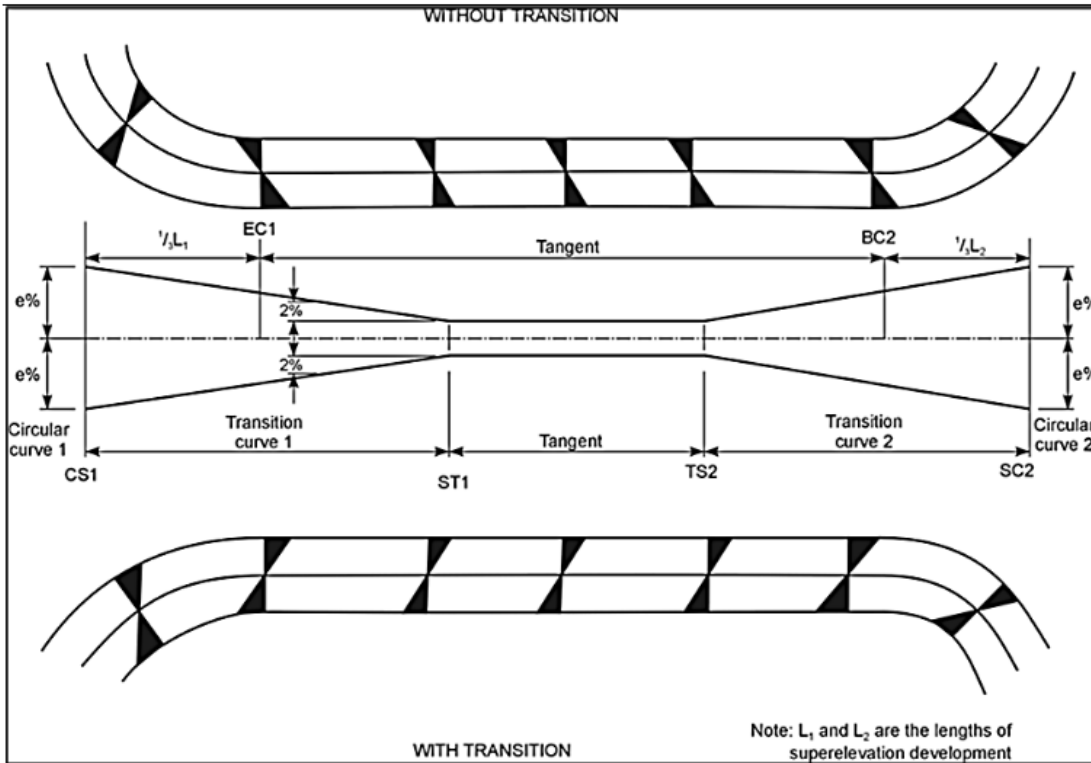

Figure 5 — Super-elevation of compound curve

7.2.7 Sight distance in horizontal curve

As illustrated on Figure 6, the sight line for general use in design of horizontal curve is a chord of the curve, and the stopping sight distance is measured along the centreline of the inside lane around the curve. Figure 2 is a design chart showing the horizontal sight line offsets needed for clear sight areas that satisfy stopping sight distance criteria for horizontal curves of various radii on flat grades.

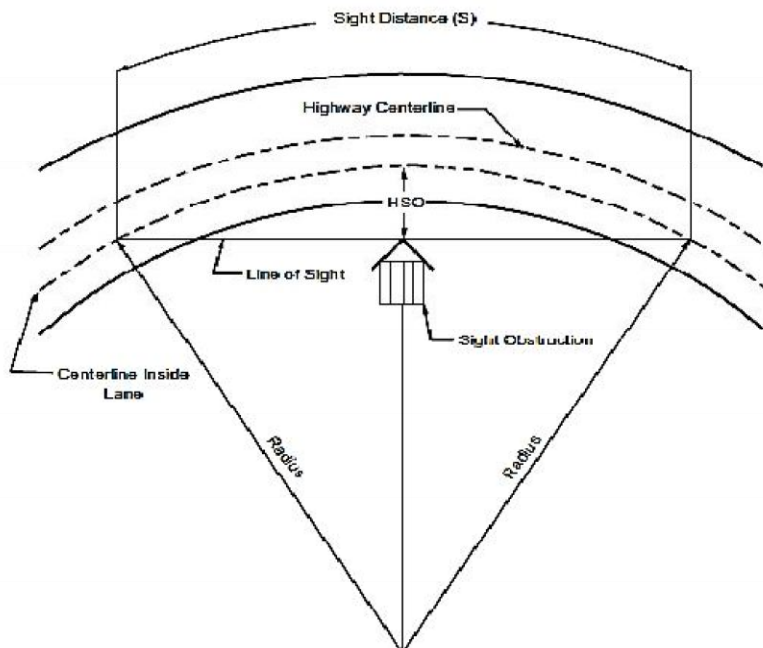

Figure 6 — Diagram illustrating components for determining horizontal sight distance

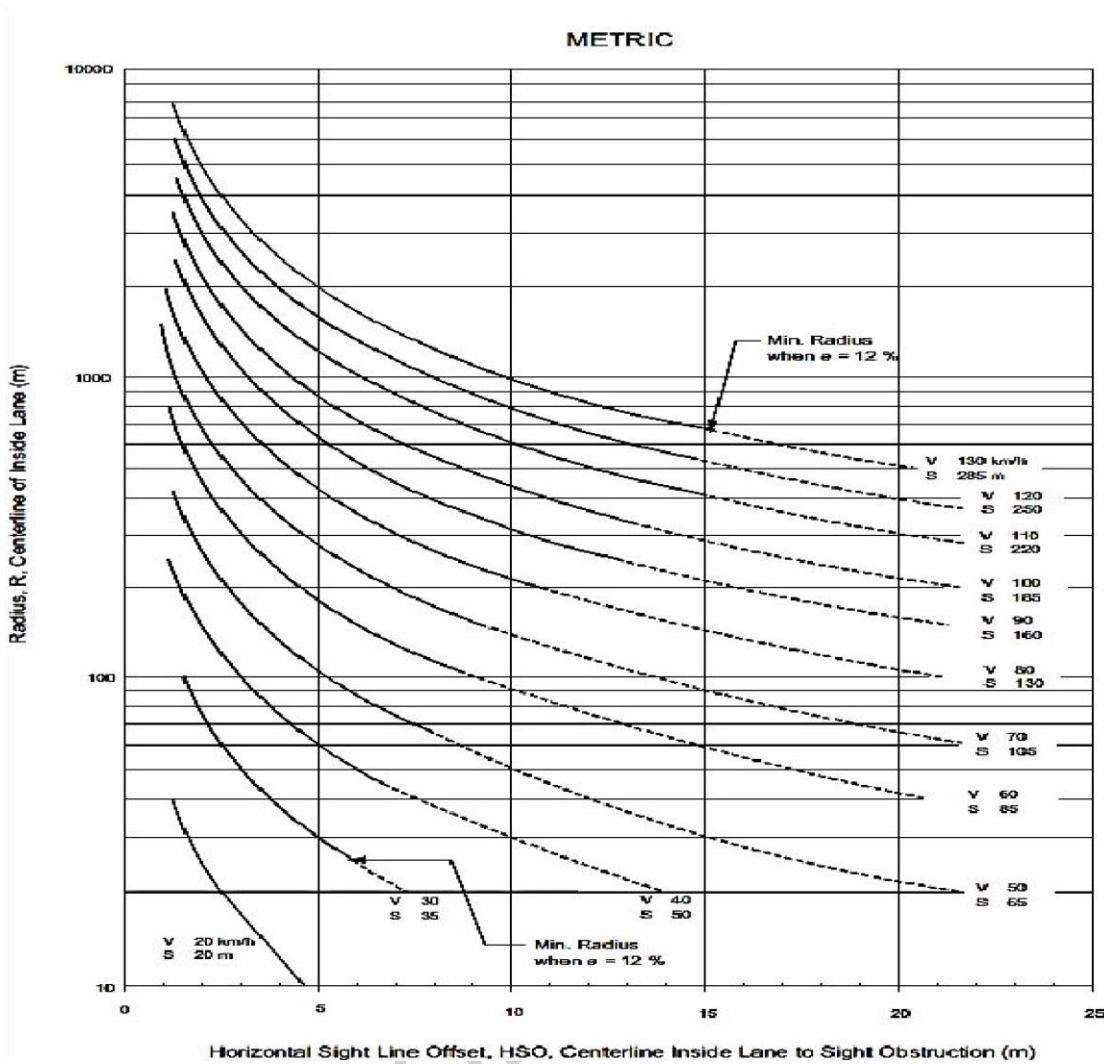

Figure 7 — Design Controls for Stopping Sight Distance on Horizontal Curves

The horizontal sightline offset is calculated using the following equation:

$$HSO = R \left[1 - \cos \left(\frac{28.655}{R} \right) \right]$$

where

HSO is horizontal sight line offset, m;

S is stopping sight distance, m;

R is radius of curve, m.

The chart from Figure 7 shall be used for corresponding applicable to design speeds and superelevations

7.2.8 Super elevation

7.2.8.1 Super-elevation development

Super-elevation development has two components: Tangent run-out and super-elevation runoff. Tangent run-out involves the rotation of the outside lane(s) of the cross-section from the normal camber, usually 2.5 per cent, to a zero cross fall. Super-elevation runoff then continues this rotation until a cross fall equal to the slope of the normal camber across the full width of the travelled way is achieved. From this point further, the entire width of the travelled way is rotated until the full super-elevation appropriate to the design speed and radius of curvature is achieved. The process is illustrated in Figure 8 for the case of rotation around the centerline.

The axis of rotation can, in fact, be located anywhere across the cross-section or even outside it. Selection of its location is dependent on the constraints under which the super elevation has to be developed. This is particularly so in the case of super-elevation development in urban areas. These constraints could involve issues of drainage, aesthetics or fitting the cross-section to the topography. The problem to be solved is largely one of the location of the road edges relative to the ground line. In the case of a two-lane road, the axis of rotation would typically be located on the centerline. Other standard locations are the inside and outside edges of the travelled way.

The rotation of dual carriageways often takes place around the outer edge of the median island so that the median shoulders rotate in concert with the travelled lanes.

However, as in the case of the two-way road, no hard and fast rules can be laid down concerning the selection of the location of the axis of rotation. It could be at the centerline of the median, at the edge of the median or even having the entire cross-section rotating as a unit around one of other of the outer edges of the cross-section. Each case would have to be considered on its own merits.

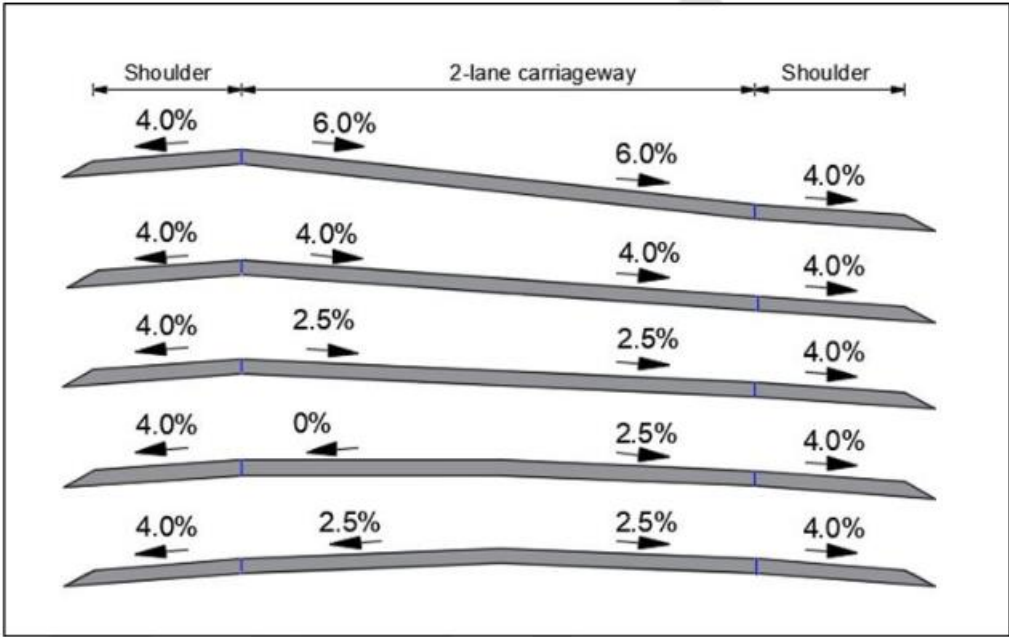

Figure 8 — Super-elevation of a two-lane carriageway about the centerline

7.2.8.2 Super-elevation runoff

The super-elevation runoff is the length of road needed to accomplish the change in cross slope from the first section in which the adverse crown was removed to the fully super-elevated section and is effected over the whole length of the spiral transition curve.

Its end point is the beginning of the circular curve itself which is denoted by SC (the Spiral to Curve transition point) or, alternatively called PC (the Point of Curvature i.e., the point where the circular curve begins).

The length of runoff, shown in Table 17 and illustrated in Figure 2 and Figure 8, is the spiral length with the tangent-to-spiral point (TS) at the beginning and the spiral-to-curve point (SC) at the end. The length of the transition curve is proportional to the total super-elevation and should not be less than the values shown in Table 17. A simple practical rule is that it must not be less than the distance travelled in 2 seconds at the design speed.

Table 17 — Minimum length of super-elevation run-off for two-lane roads

Design Speed (km/h)	Run off (m)
120	70
110	65
100	60
90	50
80	45
70	40
60	35
50	30
40	25
30	20

Table 5-7

7.2.9 Curve widening

7.2.9.1 Widening on curves and embankments

Offtracking, common to all vehicles, especially prominent in larger ones, occurs when rear wheels don't precisely follow front wheels on curves. On flat curves at low speed, rear wheels track inside front wheels; on superelevated curves, this offtracking may vary due to tire slip angle and side friction. Wheel track positioning depends on speed and friction, compensating for lateral force on superelevation. At higher speeds, rear wheels may track outside front wheels. Offtracking, influenced by curve type, speed, and tire behavior, affects vehicle maneuverability and road safety, necessitating careful design considerations for curves, especially in accommodating larger vehicles.

The widening on curves and high fills for Class 1 and 2 shall be as given in Table 18

Table 18 — Widening on curves and high fills for class 1 and 2 roads

Radius of curvature	Curve widening: Single lane (m)	Curve widening: Two lanes (m)	Maximum gradient (%)	
			Height of fill (m)	Amount (m)
>250	0.0	0.0	0.0 - 3.0	0.0
120-250	0.0	0.6	3.0 - 6.0	0.3
60-120	0.0	0.9	6.0 - 9.0	0.6
40-60	0.6	1.2	Over 9.0	0.9
20-40	0.6	1.5	Over 9.0	0.9

Note Curve with radius less than 20m are considered to be 20m (see 7.2.9.3)

7.2.9.2 Derivation of design values for widening on horizontal curves

7.2.9.2.1 The track width (U) (see Figure 9), also called swept path width, for a vehicle on a curve or turn is the sum of the tangent track width (u) and offtracking. Offtracking varies based on curve radius, articulation points, and wheelbase lengths. The formula for calculating track width on a curve (U) includes these factors.

$$U = u + R - \sqrt{R^2 - \sum L_i^2}$$

where:

U track width on curve, m;

u track width on tangent (out-to-out of tires), m;

R radius of curve or turn, m; and

L_i wheelbase of design vehicle between consecutive axles (or sets of tandem axles) and articulation points, m.

7.2.9.2.2 This equation applies to various curve configurations and considers wheelbase lengths and curve radii. For simplicity, on two-lane highways, the curve radius at the centerline is often used. On turning roadways, the radius is based on the path of the outer front wheel. Wheelbase lengths (L_i) include distances between axles and articulation points. Different types of vehicles, like single-unit trucks or articulated vehicles, have specific L_i values. Negative terms may arise if articulation points are in front of drive axles or due to rear-axle overhang. Lateral clearance allowance (C) ensures safe vehicle passage, with assumed values varying based on lane widths.

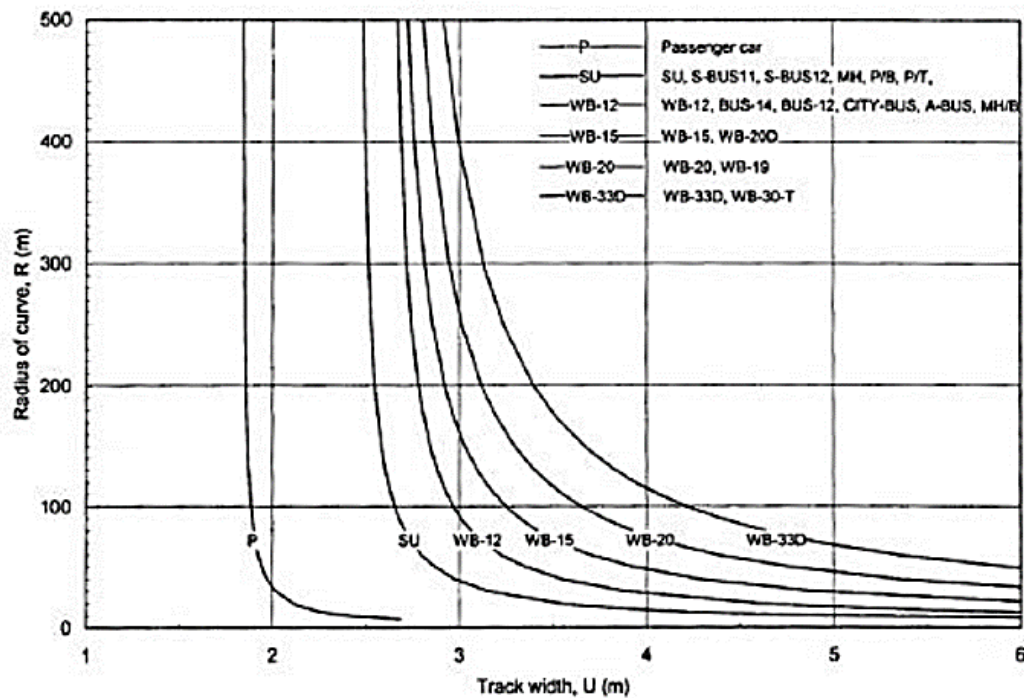

Figure 9. Track Width for Widening of Traveled Way on Curves

7.2.9.2.3 The front overhang width (FA) (see Figure 10) is the distance from the outer edge of the tire path of the outer front wheel to the outer front edge of the vehicle body. FA on curves and turning roads is influenced by curve radius, vehicle's front overhang, and wheelbase. For tractor-trailer setups, only the tractor unit's wheelbase matters.

$$F_A = \sqrt{R^2 + A(2L + A)} - R$$

where:

A front overhang of inner lane vehicle, m;

L wheelbase of single unit or tractor, m.

7.2.9.2.3 The rear overhang width (FB) is the radial distance between the inner rear tire path edge and the vehicle body's inside edge. For passenger cars (P), the body width exceeds the rear wheels' out-to-out width by 0.3 m [1 ft], resulting in FB = 0.15 m [0.5 ft]. In truck design vehicles, the body width matches the rear wheels' out-to-out width, hence FB = 0.

$$Z = 0.1(V/\sqrt{R})$$

7.2.9.2.4 The extra width allowance (Z) accounts for challenges in maneuvering on curves and driver behavior variations. It's an empirical value influenced by traffic speed and curve radius. Z provides additional radial pavement width to accommodate these factors.

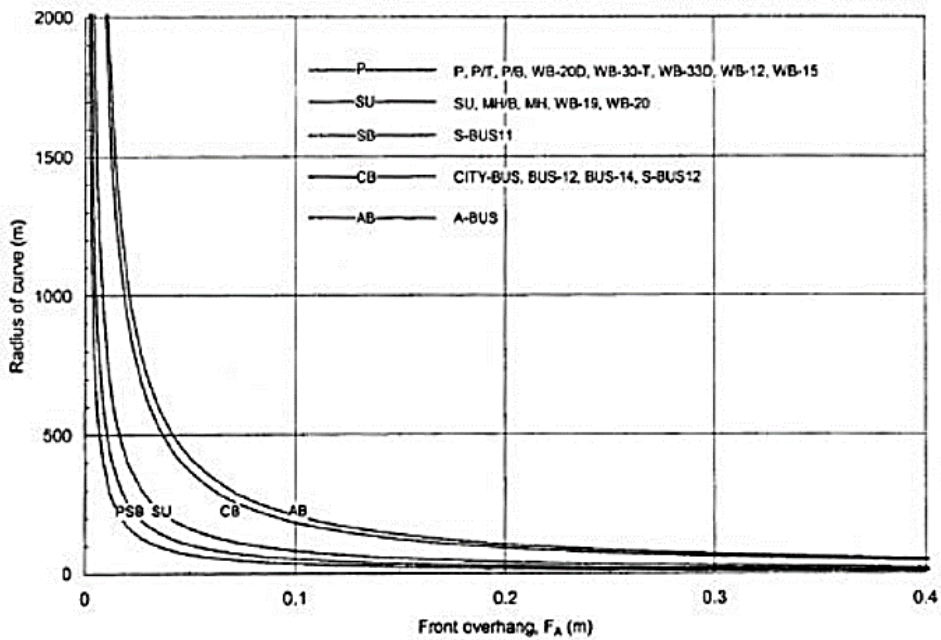

Figure 10 Front Overhang for Widening of Traveled Way on Curves

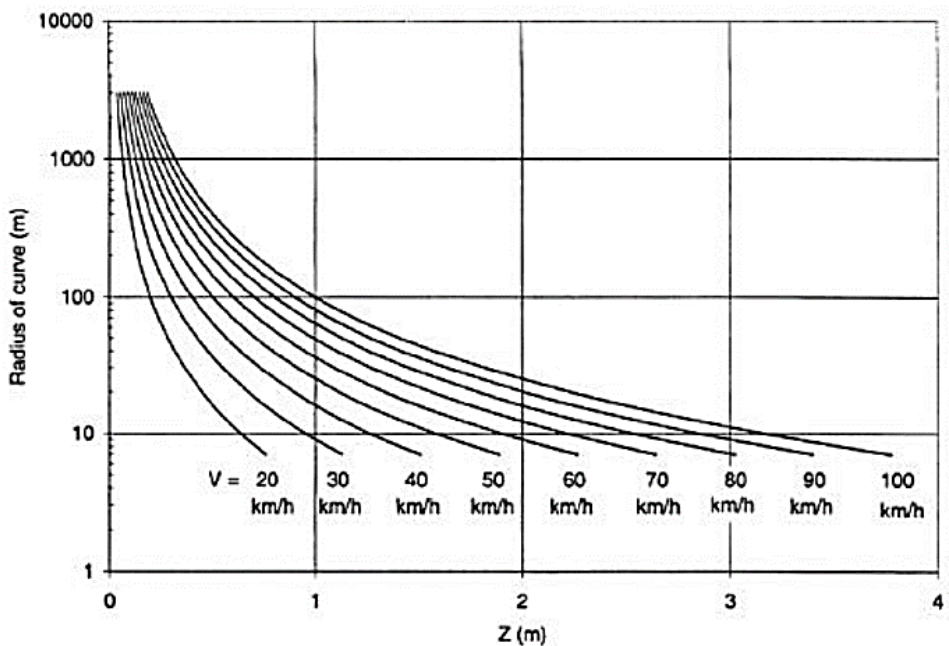

Figure 11 —Extra Width Allowance for Difficulty of Driving on Traveled Way

7.2.9.2.5 The required width of the traveled way on a curve (W_c) considers various factors including track width (U), lateral clearance (C), front overhang width (FA), and a provision for driving difficulty (Z) (see Figure 11). These components are detailed in the section on "Derivation of Design Values for Widening on Horizontal Curves." Selecting an appropriate design vehicle, typically a truck due to its significant offtracking, is necessary to calculate W_c . The WB-15 [WB-50] design vehicle is commonly used for two-lane highways, but alternative vehicles may be chosen based on specific traffic conditions.

$$w = W_c - W_n$$

where,

w widening of traveled way on curve, m;

Wc width of traveled way on curve, m;

Wn width of traveled way on tangent, m

The width Wc is calculated by the following equation:

$$W_c = N(U + C) + (N - 1) F_A + Z$$

where:

N = number of lanes;

U = track width of design vehicle (out-to-out tires), m;

C = lateral clearance, m;

FA = width of front overhang of inner-lane vehicle, m;

Z = extra width allowance, m.

7.2.9.2.6 The calculated and design values for traveled way widening on two lane open highway curves are given in Table 19.

Table 19 Calculated and design values for traveled way widening on open highway curves (two-lane)

Radius of curve (m)	Roadway width = 7.2 m						Roadway width = 6.6 m						Roadway width = 6.0 m					
	Design Speed (km/h)						Design Speed (km/h)						Design Speed (km/h)					
	50	60	70	80	90	100	50	60	70	80	90	100	50	60	70	80	90	100
3000	0.0	0.0	0.0	0.0	0.0	0.0	0.2	0.2	0.3	0.3	0.3	0.3	0.5	0.5	0.6	0.6	0.6	0.6
2500	0.0	0.0	0.0	0.0	0.0	0.0	0.2	0.3	0.3	0.3	0.3	0.3	0.5	0.6	0.6	0.6	0.6	0.6
2000	0.0	0.0	0.0	0.0	0.0	0.1	0.3	0.3	0.3	0.3	0.3	0.4	0.6	0.6	0.6	0.6	0.6	0.7
1500	0.0	0.0	0.1	0.1	0.1	0.1	0.3	0.3	0.4	0.4	0.4	0.4	0.6	0.6	0.7	0.7	0.7	0.7
1000	0.1	0.1	0.1	0.2	0.2	0.2	0.4	0.4	0.4	0.5	0.5	0.5	0.7	0.7	0.7	0.8	0.8	0.8
900	0.1	0.1	0.2	0.2	0.2	0.3	0.4	0.4	0.5	0.5	0.5	0.6	0.7	0.7	0.8	0.8	0.8	0.9
800	0.1	0.2	0.2	0.2	0.3	0.3	0.4	0.5	0.5	0.5	0.6	0.6	0.7	0.8	0.8	0.8	0.9	0.9
700	0.2	0.2	0.2	0.3	0.3	0.4	0.5	0.5	0.5	0.6	0.6	0.7	0.8	0.8	0.8	0.9	0.9	1.0
600	0.2	0.3	0.3	0.3	0.4	0.4	0.5	0.6	0.6	0.6	0.7	0.7	0.8	0.9	0.9	0.9	1.0	1.0
500	0.3	0.3	0.4	0.4	0.5	0.5	0.6	0.6	0.7	0.7	0.8	0.8	0.9	0.9	1.0	1.0	1.1	1.1
400	0.4	0.4	0.5	0.5	0.6	0.6	0.7	0.7	0.8	0.8	0.9	0.9	1.0	1.0	1.1	1.1	1.2	1.2
300	0.5	0.6	0.6	0.7	0.8	0.8	0.8	0.9	0.9	1.0	1.1	1.1	1.1	1.2	1.2	1.3	1.4	1.4
250	0.6	0.7	0.8	0.8	0.9		0.9	1.0	1.1	1.1	1.2		1.2	1.3	1.4	1.4	1.5	
200	0.8	0.9	1.0	1.0			1.1	1.2	1.3	1.3			1.4	1.5	1.6	1.6		
150	1.1	1.2	1.3	1.3			1.4	1.5	1.6	1.6			1.7	1.8	1.9	1.9		
140	1.2	1.3					1.5	1.6					1.8	1.9				
130	1.3	1.4					1.6	1.7					1.9	2.0				
120	1.4	1.5					1.7	1.8					2.0	2.1				
110	1.5	1.6					1.8	1.9					2.1	2.2				
100	1.6	1.7					1.9	2.0					2.2	2.3				
90	1.8						2.1						2.4					
80	2.0						2.3						2.6					
70	2.3						2.6						2.9					

Notes: Values shown are for WB-15 design vehicle and represent widening in meters. For other design vehicles, use adjustments in Table 3. Values less than 0.6 m may be disregarded. For 3-lane roadways, multiply above values by 1.5. For 4-lane roadways, multiply above values by 2.

7.2.9.2.7 The traveled way widening values on open highway curves shall be adjusted as per Table 20

Table 20— Adjustments for Traveled Way Widening Values on Open Highway Curves (Two-Lane Highways,

Radius of curve (m)	Design vehicle						
	SU	WB-12	WB-19	WB-20	WB-20D	WB-30T	WB-33D
3000	-0.3	-0.3	0.0	0.0	0.0	0.0	0.1
2500	-0.3	-0.3	0.0	0.0	0.0	0.0	0.1
2000	-0.3	-0.3	0.0	0.0	0.0	0.0	0.1
1500	-0.4	-0.3	0.0	0.1	0.0	0.0	0.1
1000	-0.4	-0.4	0.1	0.1	0.0	0.0	0.2
900	-0.4	-0.4	0.1	0.1	0.0	0.0	0.2
800	-0.4	-0.4	0.1	0.1	0.0	0.0	0.2
700	-0.4	-0.4	0.1	0.1	0.0	0.0	0.3
600	-0.5	-0.4	0.1	0.1	0.0	0.1	0.3
500	-0.5	-0.4	0.1	0.2	0.0	0.1	0.4
400	-0.5	-0.4	0.2	0.2	0.0	0.1	0.5
300	-0.6	-0.5	0.2	0.3	-0.1	0.1	0.6
250	-0.7	-0.5	0.2	0.3	-0.1	0.1	0.8
200	-0.8	-0.6	0.3	0.4	-0.1	0.2	1.0
150	-0.9	-0.7	0.4	0.6	-0.1	0.2	1.3
140	-0.9	-0.7	0.4	0.6	-0.1	0.2	1.4
130	-1.0	-0.7	0.5	0.6	-0.2	0.2	1.5
120	-1.1	-0.8	0.5	0.7	-0.2	0.3	1.6
110	-1.1	-0.8	0.6	0.8	-0.2	0.3	1.7
100	-1.2	-0.9	0.6	0.8	-0.2	0.3	1.9
90	-1.3	-0.9	0.7	0.9	-0.2	0.3	2.1
80	-1.4	-1.0	0.8	1.1	-0.2	0.4	2.4
70	-1.6	-1.1	0.9	1.2	-0.3	0.5	2.8

Notes: Adjustments are applied by adding to or subtracting from the values in Table 2. Adjustments depend only on radius and design vehicle; they are independent of roadway width

and design speed. For 3-lane roadways, multiply above values by 1.5. For 4-lane roadways, multiply above values by 2.0.

7.2.9.3 Width for turning roadways at intersections

The typical pavement width shall for turning roadways shall be as per Table 21 Intersection turning roadways accommodate vehicles based on size, curvature radius, and speed, allowing for one- or two-way operation.

Table 21 —Derived pavement widths for turning roadways for different design vehicles

Radius on Inner Edge of Pavement R (m)	Case I, One-Lane, One-Way Operation, No Provision for Passing a Stalled Vehicle																		
	P	SU	BUS-12	BUS-14	CITY-BUS	S-BUS11	S-BUS12	A-BUS	WB-12	WB-15	WB-19	WB-20	WB-20D	WB-30T	WB-33D	MH	P/T	P/B	MH/B
15	4.0	5.5	6.6	7.2	6.5	5.7	5.5	6.7	7.0	9.7	13.3	15.7	8.8	11.6	--	5.5	5.7	5.4	6.5
25	3.9	5.0	5.7	5.9	5.6	5.1	5.0	5.7	5.8	7.2	8.5	9.0	6.8	7.9	12.0	5.0	5.1	4.9	5.5
30	3.8	4.9	5.4	5.7	5.4	5.0	4.9	5.5	5.5	6.7	7.7	8.1	6.3	7.3	10.4	4.9	5.0	4.8	5.3
50	3.7	4.6	5.0	5.2	5.0	4.7	4.6	5.0	5.0	5.7	6.3	6.5	5.5	6.1	7.7	4.6	4.7	4.6	4.9
75	3.7	4.5	4.8	4.9	4.8	4.5	4.5	4.9	4.8	5.3	5.7	5.9	5.2	5.6	6.7	4.5	4.5	4.5	4.7
100	3.7	4.5	4.8	4.9	4.8	4.5	4.5	4.9	4.8	5.3	5.7	5.9	5.2	5.6	6.7	4.5	4.5	4.5	4.7
125	3.7	4.5	4.8	4.9	4.8	4.5	4.5	4.9	4.8	5.3	5.7	5.9	5.2	5.6	6.7	4.5	4.5	4.5	4.7
150	3.7	4.5	4.8	4.9	4.8	4.5	4.5	4.9	4.8	5.3	5.7	5.9	5.2	5.6	6.7	4.5	4.5	4.5	4.7
Tangent	3.6	4.2	4.4	4.4	4.4	4.2	4.2	4.4	4.2	4.4	4.4	4.4	4.4	4.4	4.4	4.2	4.2	4.2	4.2
	Case II, One-Lane, One-Way Operation with Provision for Passing a Stalled Vehicle by Another of the Same Type																		
15	6.0	9.2	11.9	13.1	11.7	9.4	9.7	12.4	11.8	17.3	24.7	29.5	15.4	20.9	--	9.2	9.3	8.7	11.0
25	5.6	7.9	9.6	10.2	9.5	8.0	8.2	9.9	9.3	12.1	14.9	16.0	11.2	13.5	21.7	7.9	7.9	7.6	8.9
30	5.5	7.6	9.0	9.5	9.0	7.7	7.8	9.3	8.8	11.1	13.3	14.2	10.4	12.2	18.4	7.6	7.6	7.4	8.4
50	5.3	7.0	8.0	8.3	7.9	7.0	7.1	8.1	7.7	9.1	10.4	10.9	8.7	9.8	13.1	7.0	7.0	6.8	7.5
75	5.2	6.7	7.4	7.6	7.4	6.7	6.8	7.5	7.1	8.2	9.0	9.3	7.9	8.6	10.8	6.7	6.7	6.6	7.0
100	5.2	6.5	7.2	7.3	7.1	6.6	6.6	7.2	6.9	7.7	8.3	8.6	7.5	8.1	9.7	6.5	6.5	6.5	6.8
125	5.1	6.4	7.0	7.1	7.0	6.5	6.5	7.1	6.7	7.5	8.0	8.1	7.3	7.7	9.0	6.4	6.4	6.4	6.6
150	5.1	6.4	6.9	7.0	6.9	6.4	6.4	7.0	6.6	7.3	7.7	7.8	7.2	7.5	8.6	6.4	6.4	6.3	6.5
Tangent	5.0	6.1	6.4	6.4	6.4	6.1	6.1	6.4	6.1	6.4	6.4	6.4	6.4	6.4	6.1	6.1	6.1	6.1	6.1
	Case III, Two-Lane Operation, Either One or Two-Way (Same Type Vehicle in Both Lanes)																		
15	7.8	11.0	13.7	14.9	13.5	11.2	11.5	14.2	13.6	19.1	26.5	31.3	17.2	22.7	--	11.0	11.1	10.5	12.8
25	7.4	9.7	11.4	12.0	11.3	9.8	10.0	11.7	11.1	13.9	16.7	17.8	13.0	15.3	23.5	9.7	9.7	9.4	10.7
30	7.3	9.4	10.8	11.3	10.8	9.5	9.6	11.1	10.6	12.9	15.1	16.0	12.2	14.0	20.2	9.4	9.4	9.2	10.2
50	7.1	8.8	9.8	10.1	9.7	8.8	8.9	9.9	9.5	10.9	12.2	12.7	10.5	11.6	14.9	8.8	8.8	8.6	9.3
75	7.0	8.5	9.2	9.4	9.2	8.5	8.6	9.3	8.9	10.0	10.8	11.1	9.7	10.4	12.6	8.5	8.5	8.4	8.8
100	7.0	8.3	9.0	9.1	8.9	8.4	8.4	9.0	8.7	9.5	10.1	10.4	9.3	9.9	11.5	8.3	8.3	8.3	8.6
125	6.9	8.2	8.8	8.9	8.8	8.3	8.3	8.9	8.5	9.3	9.8	9.9	9.1	9.5	10.8	8.2	8.2	8.2	8.4
150	6.9	8.2	8.7	8.8	8.7	8.2	8.2	8.8	8.4	9.1	9.5	9.6	9.0	9.3	10.4	8.2	8.2	8.1	8.3
Tangent	6.8	7.9	8.2	8.2	8.2	7.9	7.9	8.2	7.9	8.2	8.2	8.2	8.2	8.2	8.2	7.9	7.9	7.9	7.9

7.2.9.3 Switchback curves

Switchback or hairpin curves (see Figure 12) are curves with a radius of 20m or less but not less than 15m. They are mostly necessary in traversing mountainous and steep terrain,

Switchback curves require a careful design to ensure that all design vehicles can travel through the curve. They must therefore provide for the tracking widths of the design vehicles as it indicated in the figure 1 & 2. Minimum outer radii for design vehicles DV2 through DV4 are 12.5m, 14.1m, and 12.5m, respectively. Minimum inner radii are 8m, 7.4m, and 6m, respectively. Switchback requirements can be determined which allow for:

- a) Passage of two opposing DV4 vehicles. This is recommended for road Classes 1-2; however, these road classes should not use switchback curves
- b) Passage of a single DV4 and a DV1. This is recommended for road Classes 3-4

- c) Passage of only a single DV4. This is recommended for road Classes 5 and single lane roads Figure 2. illustrates the elements of a switchback curve. By superimposing for design vehicle DV4 vehicle at a time on a Class 5 road.

Note that this figure shows that the vehicle must use both lanes to make the maneuver. The radii minimum values which allow for this are: $R = 10\text{m}$, $R_i = 6\text{m}$, $R_s = 14\text{m}$

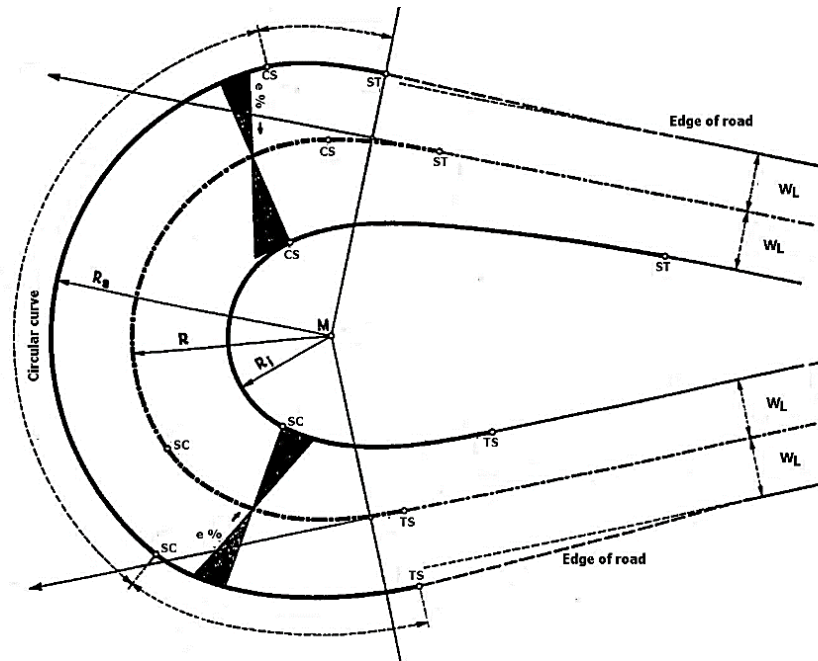

Figure 12. Switchback Curve Layout

Thus, although the normal carriageway width for a Class 5 road is 6.0m, at the switchback curve a width of least 8m is required if the road needs to allow for the passage of a single DV4 vehicle at a time. For provision for opposing DV4 vehicles passing at the same time, the width must be much greater. Requirements vary depending on road class, passage requirements, radius, deflection angle, and design standard, and a template should be used based on the design vehicle turning radii to ensure that all design vehicles can negotiate each switchback. It is important to provide relief from a severe gradient through the switchback.

7.3 Vertical alignment

7.3.1 Gradients

Maximum grades vary, depending on the type of facility, and usually do not constitute an absolute standard. The effect of a steep grade is to slow down the heavier vehicles and increasing operating costs and the extent to which any heavier vehicle is slowed depends on both the steepness and length of the grade. The minimum gradient for roads in cutting taken into account to avoid standing water in side ditches, is recommended to

The recommended minimum grade for the roadway design is 0.5% and the recommended maximum grades which are based on which varies with the terrain category are given in Table 22.

Table 22 — Recommended maximum grade

Terrain	Maximum gradient (%)
Flat	6
Rolling	4 – 8

Mountainous	7 – 12
Steep	12 - 18

7.3.2 Climbing lanes

The climbing lane shall be provided with the effect of reducing congestion in the through lanes by removing slower-moving vehicles from the traffic stream. As such, it is used to match the Level of Service on the rising grade to that prevailing on the level sections of the route. The climbing lane help the maintenance of an acceptable level of service over a section of the route and the enhancement of road safety by the reduction of the speed differential in the through lane.

The following are warrants for climbing lanes, that are based on both the speed and volume of the traffic:

- i) Upgrade traffic flow rate in excess of 200 vehicles per hour
- ii) Upgrade truck flow rate in excess of 20 vehicles per hour
- iii) One of the following conditions exists:
 - a) A 15 km/h or greater speed reduction is expected for a typical heavy truck
 - b) Level of service E or F exists on the grade
 - c) A reduction of two or more levels of service is experienced when moving from the approach segment to the grade.

In addition, safety considerations may justify the addition of a climbing lane regardless of grade or traffic volumes enhancement of road safety by the reduction of the speed differential in the through lane.

7.3.3 Vertical curves

7.3.3.1 General

Minimum lengths of vertical curves shall be based on stopping sight distance criteria and the length of a curve (in metres) should not be shorter than the design speed. In the case of freeways, the minimum length shall not be less than twice the design speed in km/h.

For crest vertical curves, the minimum length standard depends on the stopping sight distance, the height of the driver's eye measured from an eye height of 1.05 m, and the height of the object of 0.6 m to be seen over the crest of the curve.

For sag curves, stopping sight distance is based on the distance illuminated by the headlight height of 0.6 m at night.

7.3.3.2 Crest curve

7.3.3.1 Vertical curves shall be designed to be simple in application and should result in a design that is safe and comfortable in operation, pleasing in appearance, and adequate for drainage. The major control for safe operation on crest curves is the provision of ample sight distances for the design speed.

7.3.3.2 It is recommended that all vertical curves should be designed to provide at least the stopping sight distances and additional sight distance should be provided at decision points. For driver comfort, the rate of change of grade should be kept within tolerable limits. This consideration is most important in sag vertical curves where gravitational and vertical centripetal forces act in opposite directions. Appearance also should be considered in designing vertical curves. A long curve has a more pleasing appearance than a short one;

short vertical curves may give the appearance of a sudden break in the profile due to the effect of foreshortening.

7.3.3.3 Parameters illustrated in Figure 13 shall be used in determining the length of a parabolic vertical curve needed to provide a specified value of sight distance. The basic equation of a crest vertical curve in terms of algebraic difference in grade and sight distance is given below:

When S is less than L ,

$$L = \frac{AS^2}{100 \left(\sqrt{2h_1} + \sqrt{2h_2} \right)^2}$$

When S is greater than L ,

$$L = 2S - \frac{200 \left(\sqrt{h_1} + \sqrt{h_2} \right)^2}{A}$$

where

L is length of vertical curve, m;

A is algebraic difference in grades, %;

S is sight distance, m;

h_1 height of eye above roadway surface, m;

h_2 height of object above roadway surface, m.

7.3.3.4 When the height of the eye and of the object are respectively 1.08 m and 0.6 m as used for stopping sight distance; equation should be simplified to the following:

When S is less than L ,

$$L = \frac{AS^2}{658}$$

When S is greater than L ,

$$L = 2S - \frac{658}{A}$$

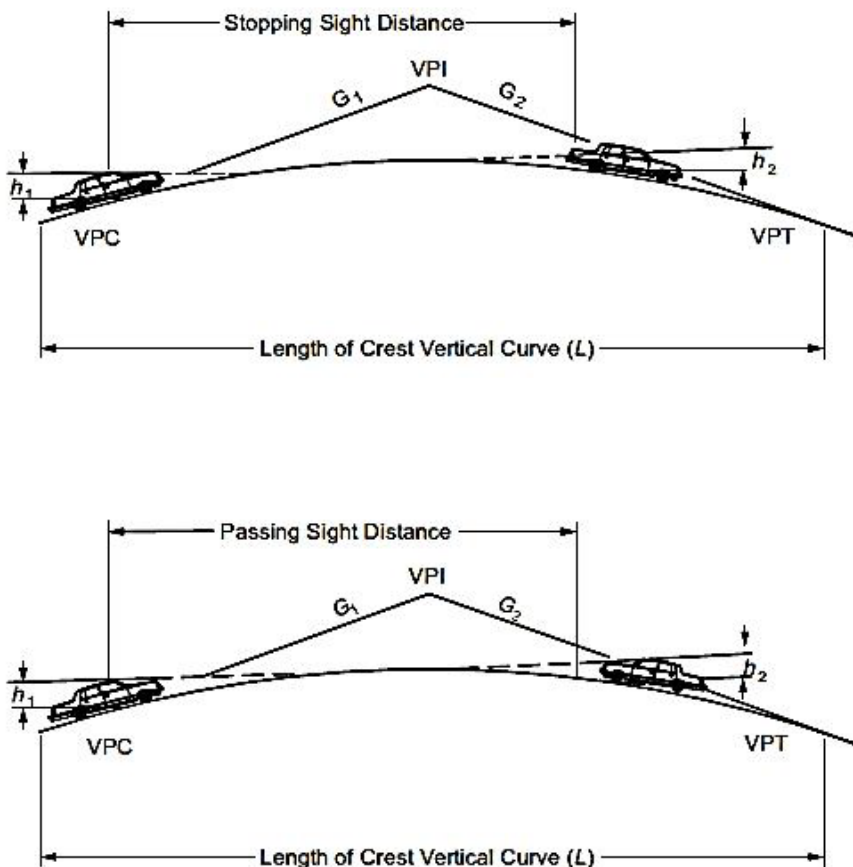

Figure 13 — Parameters considered in determining the length of the crest vertical curve to provide sight distance

The horizontal circular curve provides a constant rate of change of bearing. Analogous to this is the vertical parabola which provides a constant rate of change of gradient. The reciprocal of the rate of change of grade, K , is thus the distance required to effect a unit change of grade. Vertical curves are specified in terms of this factor, K , and their horizontal length calculated by multiplying K by the algebraic difference, A , in percentage between the gradients on either side of the curves so that:

$$L = A \times K.$$

Table 23 and Table 24 gives the computed K values for lengths of vertical curves corresponding to the stopping sight distances and passing sight distance respectively.

Table 23 — Design controls for stopping sight distance and crest vertical curves

Design speed (km/h)	Stopping sight distance (m)	Rate of vertical curvature, K^a	
		Calculated	Design
20	20	0.6	1
30	35	1.9	2
40	50	3.8	4

50	65	6.4	7
60	85	11.0	11
70	105	16.8	17
80	130	25.7	26
90	160	38.9	39
100	185	52.0	52
110	220	73.6	74
120	250	95.0	95
130	285	123.4	124
^a Rate of vertical curvature, k, is the length of curve per percent algebraic difference in intersecting grades (A). $K=L/A$			

The design control in terms of K covers all combinations of A and L for any one design speed and therefore A and L need not be indicated separately in a tabulation of design value. The selection of design curves is facilitated because the minimum length of curve in metre is equal to K times the algebraic difference in grades in percent, $L=KA$. Conversely, the checking of plans is simplified by comparing all curves with the design value for K.

Table 24 — Design controls for crest vertical curves based on passing sight Distance

Design speed (km/h)	Stopping sight distance (m)	Rate of vertical curvature, K^a , Design
30	200	46
40	270	84
50	345	138
60	410	195
70	485	272
80	540	338
90	615	438
100	670	520
110	730	617
120	775	695
130	815	769
^a Rate of vertical curvature, K, is the length of curve per percent algebraic difference in the intersecting grades (A). $K=L/A$		

7.3.3.3 Sag curve

7.3.3.3.1 Four different criteria for establishing lengths of sag vertical curves should be recognized to some extent. These are:

- a) headlight sight distance;

- b) passenger comfort;
- c) drainage control; and
- d) general appearance.

7.3.3.3.2 A headlight height of 0.6 m and a one-degree upward divergence of the light beam from the longitudinal axis of the vehicle is commonly assumed. The following relationship between S, L and A, using S as a distance between the vehicle and the point where one-degree upward angle of the light beam intercepts the surface of the roadway:

When S is less than L,

$$L = \frac{AS^2}{200[0.6 + S(\tan 1^\circ)]}$$

Or,

$$L = \frac{AS^2}{120 + 3.5S}$$

When S is greater than L,

$$L = 2S \frac{200[0.6 + S(\tan 1^\circ)]}{A}$$

Or,

$$L = -\frac{120 + 3.5S}{A}$$

where

- L is length of sag vertical curve;
- A is algebraic difference in grades, %;
- S is light beam distance, m.

7.3.3.3.3 For drivers to see the roadway ahead, a sag vertical curve should be long enough that the light beam distance is approximately the same at the stopping sight distance. Accordingly, it is appropriate to use stopping sight distances for different design speeds as the value of S in the above equations. The resulting lengths of the sag vertical curves for the recommended stopping sight distances for each design speed are shown in Figure 14 with solid lines using rounded values of K as was done for crest vertical curves.

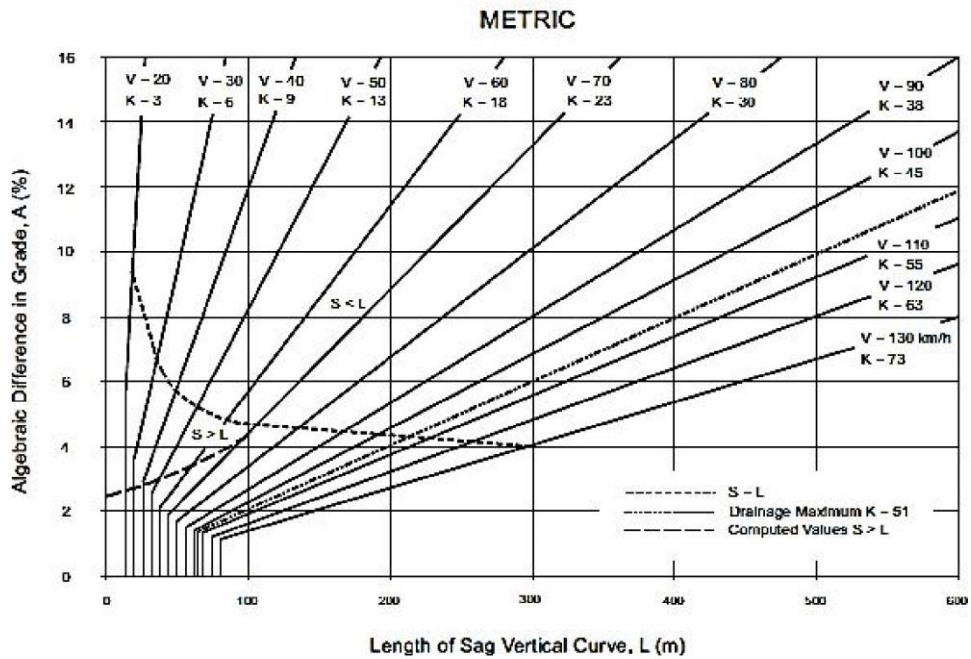

Figure 14 — Length of sag vertical curve as a function of algebraic difference in grade A (%)

7.3.3.3.4 Same lengths of sag vertical curves as that of the stopping sight distance should be used and the rate of vertical curves should be determined accordingly.

Table 25 — Design controls for Sag Vertical curves

Design speed (km/h)	Stopping sight distance (m)	Rate of vertical curvature, K^a	
		Calculated	Design
20	20	2.1	3
30	35	5.1	6
40	50	8.5	9
50	65	12.2	13
60	85	17.3	18
70	105	22.6	23
80	130	29.4	30
90	160	37.6	38
100	185	44.6	45
110	220	54.4	55
120	250	62.8	63
130	285	72.7	73

^a Rate of vertical vertical curvature, K, is the length of curve (m) per percent algebraic difference intersecting (A). $K=L/A$

7.3.3.4 Sight distances at undercrossing

7.3.3.4.1 In some conditions, it is recommended to check the available sight distance at undercrossing such as at an undercrossing without ramp where passing sight distance need to be provided (Figure 15).

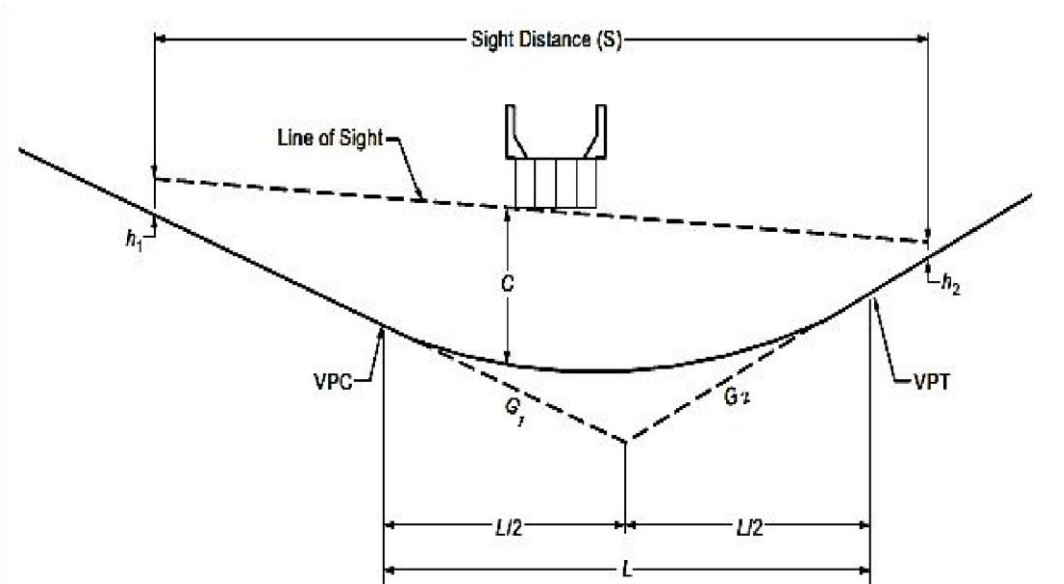

Figure 15 — Schematic view of sight distance at undercrossing

7.3.3.4.1 General equations should be developed for two cases as follows:

A. Case 1 Sight distance greater than length of vertical curve ($S > L$)

$$L = 2S \frac{800 \left[C - \frac{h_1 + h_2}{2} \right]}{A}$$

where

L is length of vertical curve, m;

S is sight distance, m;

C is vertical clearance, m;

h_1 is height of eye, m;

h_2 is height of object, m;

A is algebraic difference in grades, %.

B. Case 2 Sight distance less than length of vertical curve ($S < L$)

$$L = \frac{AS^2}{800 \left[C - \frac{h_1 + h_2}{2} \right]}$$

where

L length of vertical curve, m;

A is algebraic difference in grades, %;

S is sight distance, m;

h_1 is height of eye, m;

h_2 is height of object, m.

7.3.3.4.2 Using an eye height of 2.4 m for truck driver and an object of height of 0.6 m for the taillights of a vehicle, the following equations can be derived:

A. Case 1 Sight distance greater than length of vertical curve ($S > L$)

$$L = 2S - \frac{800(C - 1.5)}{A}$$

B. Case 2 Sight distance less than length of vertical curve ($S < L$)

$$L = \frac{AS^2}{800(C - 1.5)}$$

7.3.3.4.3 The sight distance undercrossing shall be determined for two cases where:

A. is the sight distance is greater than the vertical curve;

B. is the sight distance is less than the vertical curve.

7.3.3.4.4 The cases of a truck driver's eye from 2.4 m staring an object of 0.6 m height for the taillights of a vehicle shall as well be considered.

8 Cross Section Elements

8.1 Lane Width

8.1.1 The width travel lane shall be sufficient to accommodate the design vehicle, allow for imprecise steering manoeuvres, and provide clearance for opposing flow in adjacent lanes. In cases of paved road, lane width refers to the net width excluding width of edge strip, edge line and centreline markings.

8.1.2 The design width of a travelled lane shall be:

- a) 3.5 to 3.75 m wide, for mobility roads of Class 1, Class 2 and Class 3, and
- b) 2.5 to 3.5 m wide for roads of Class 4 and Class 5.

In suburbs and at the entrance of a town or city, of a grouped settlement or agglomeration, the road width may be increased where necessary.

8.1.3 Wide lanes promote the safety of the occupants of vehicles, although current evidence suggests that there is an upper limit beyond which safety is reduced by further increases in lane width. The selection of lane width is based on traffic volume and vehicle type and speed.

8.2 Shoulders

8.2.1 Shoulders should be wide enough to adequately fulfil their purpose, but excessive width encourages drivers to use them as an additional travel lane. Shoulders are used for emergency stopping, for parking of disabled vehicles, and for lateral support of the subbase, base, and surface courses of the travel roadway. In

cases of paved road, lane width covers net width excluding width of edge strip, edge line and centreline markings.

- 8.2.2 The minimum width of shoulders for mobility roads of Class 1, shall be 2.5 m
- 8.2.3 The minimum width of shoulders for roads of Class 2 and Class 3, shall be at least 2 m.
- 8.2.4 The width of shoulders for roads in rolling mountainous and steep terrain shoulders shall be 1 to 1.5m.
- 8.2.5 For access roads of Class 4 and Class 5, shoulders shall be at least 1.0 m wide for both sides of the road.
- 8.2.6 The shoulder area shall be free from any object that can obstruct the movement of pedestrians. Any roadway structure including bridges head walls and any physical structure projecting upward that can disrupt the pedestrian movement shall be fixed outside the shoulder width.

8.3 Normal Cross Fall (NCF)

8.3.1 The divided roadway is designed as two separate roadways, each having a centre crown bordered by slopes to the outside of the pavement, or each direction of travel can be sloped unidirectional. The cross slope is used on traffic lanes to promote drainage of surface water.

8.3.2 The recommended cross slope varies depending on the surface of pavement ranging from asphalt concrete surface, surface dressing surface, stone paved surface and gravel and earth surface, and shall be as follows:

- a) 2.5% for asphalt concrete surfaces (or 3% in areas where heavy rainfall is common)
- b) Surface dressing surfaces 3.0%
- c) Stone paved surfaces 3.0%
- d) Gravel and earth surfaces 4.0%

8.3.3 The shoulder should have the same slope as the carriageway.

8.4 Side Slope and back slope

8.4.1 Side slopes shall be designed to ensure roadway stability and provide a reasonable opportunity for recovery for an out-of-control vehicle. Three regions of the side slopes shown in Figure 16 are important to safety: the top of the slope (hinge point), the fore slope, and the toe of the slope (intersection of the fore slope with level ground or with a back slope, forming a ditch), the

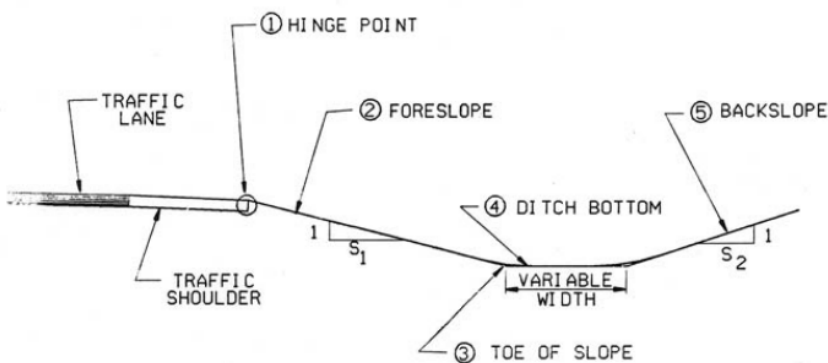

Figure 16 — Typical illustration of regions of side slopes

8.4.2 The slope steeper than 1V:4H are not desirable because their use severely limits the choice of back slopes. Slope 1V:3H or steeper are recommended only where site conditions do not permit use of flatter slopes. When slopes steeper than 1V:3H are used, consideration should be given to the use of a roadside barrier.

8.4.3 Back slopes should be 1V:3H or flatter, to accommodate maintenance equipment. Back slopes steeper than 1V:3H should be evaluated with regard to soil stability and traffic safety. Retaining walls should be considered where space restrictions would otherwise result in slopes steeper than 1V:2H.

8.4.4 For freeways and other arterials, it is recommended that the rate of slope of 1V:6H or flatter be provided on embankments since they can be negotiated by a vehicle with a good chance of recovery. For moderate heights with good roundings, steeper slopes up to about 1V:3H can also be traversable, though not recoverable.

8.4.5 It is recommended that:

- a) For side slopes steeper than 1V:3H, roadside barrier should be used.
- b) Back slopes should be flatter than 1V:3H to accommodate maintenance equipment
- c) The slopes steeper than 1V:3H should be evaluated for slope stability and traffic safety

8.5 Clear Zone

This is an unobstructed, relatively flat area provided beyond the edge of the roadway for the recovery of errant vehicles. It includes any shoulders or auxiliary lanes. Clear zone widths are related to speed, volume, embankment slope, and horizontal geometry. The need for clear zones increases with speed and curvature.

The recommended clear zone width design values in relation to speed limits shall be as per Table 26.

Table 26 — Clear zone widths

Speed limit (km/h)	Standard	
	Desired (m)	Minimum (m)
70	5	3
80	6	4
100	9	6

The values shown in Table 20 should be increased at sharp bends on high speed roads by a correction factor.

8.6 Median

8.6.1 Median width is expressed as the dimension between the edges of travelled way and includes the left/right shoulder (depending on whether driving is on the right/left, respectively), if any. Medians are highly desirable on multilane divided arterials carrying four or more lanes.

8.6.2 The median shall be appropriate so as to properly fulfil its main functions including to separate opposing traffic, provide recovery area for out-of-control vehicles, provide a stopping area in case of emergencies, allow space for speed changes and storage of left/right-turning (depending on whether driving is on the right/left, respectively) and U-turning vehicles, minimise headlight glare, provide width for future lanes, and in urban areas to offer an open green space, refuge area for pedestrians crossing the street, and control the location of intersection traffic conflicts.

The design width dimensions in relation to the speed limits shall be as per the Table 27.

Table 27 — Recommended median widths

Speed limit (km/h)	Median Widths	
	Desirable (m)	Minimum (m)
100	12	6
80	9	4

8.7 Service Roads

8.7.1 A service road, also known as access road or frontage roads, serves numerous functions, depending on the type of arterial they serve and the character of the surrounding area. They may be used to control access to the arterial, function as a street facility serving adjoining properties, and maintain circulation of traffic on each side of the arterial. Service roads segregate local traffic from the higher speed through-traffic and intercept driveways of residences and commercial establishments along the highway.

8.7.2 Cross connections provide access between the roadway and service roads and are usually located in the vicinity of the crossroads. Thus, the through character of the highway is preserved and unaffected by subsequent development of the roadsides. Service roads are used on all types of highways. Despite the advantages of using service roads on arterials roads, the use of continuous service roads on relatively high-speed arterial roads with intersections may be undesirable.

8.7.3 The design of service road is influenced by the type of service it is intended to provide. The recommended service road width for larger trading centres and towns is 6.0 m, however, lower widths may be adopted depending on the intended function of the service road. A spacing of about 50 m between the arterial and the service roads in urban areas is recommended.

8.8 Headroom and Lateral Clearance
8.8.1 The roadway shall be designed with enough headroom to allow the traffic to pass safely under objects restricting the height, mainly under bridge structures, high-power cable and low-power cable.

8.8.2 The recommended headroom shall be 5.5 m under bridge structures, 7.0 m under high-power cables and 6.0 m under low-power cables.

8.8.3 The minimum lateral clearance shall be provided and shall have the width of;

- (i) width of 0.6 m on each side of a bridge for traffic volume of less than 400 veh/day,
- (ii) width of 1.0 to 1.2 m on each side of a bridge for traffic volume of 400 to 2000 veh/day, and
- (iii) width of approach roadway width for traffic volume of over 2000 veh/day

8.8.4 For bridges over 30 m span, the width of lateral clearance shall be increased by 1 m.

8.9 Typical Cross Section Dimensions

The typical cross section dimensions for road design given in Table 28 are developed based on the proposed standards discussed in the previous sections. Figure 17 presents typical cross sectional elements of a dual carriageway.

Table 28 — Typical cross section dimensions for a road design

Road class	Dimension (m)						Slope (%)	
	Right of way	Roadway width	Carriageway width	Number of lanes	Lane width	Shoulder width	Cross slope	Shoulder slope
Mobility roads class 1	60.0	11.4	7.4	2	3.7	2.0	2.5	4.0

Mobility roads class 3	40.0	10.0	7.0	2	3.5	1.5	2.5	4.0
Access roads class 4	30.0	8.6	6.6	2	3.3	1.0	4.0	4.0

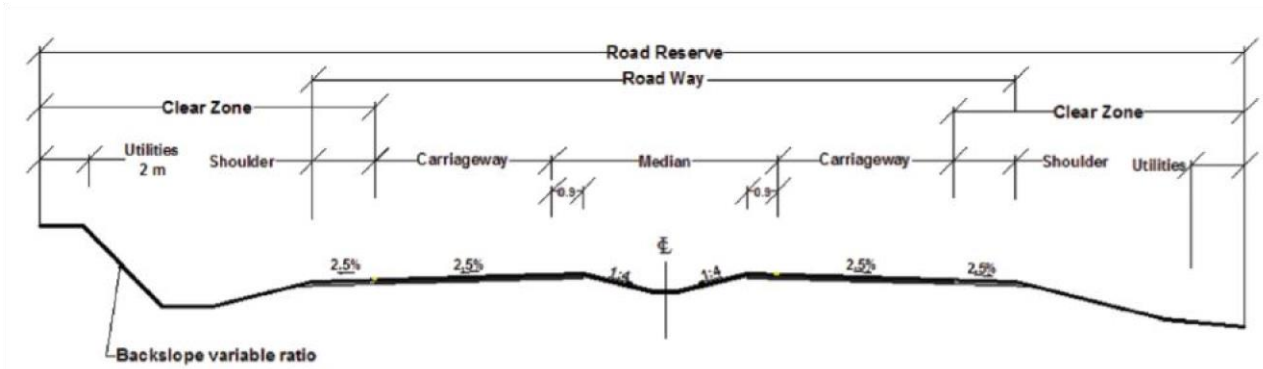

Figure 17 — Typical cross sectional elements of a dual carriageway

8.10 Motorcycle Lanes

8.10.1 The motorcycle lanes can be either restricted track type of exclusive track type.

8.10.2 Restricted motorcycle track can be developed within the carriageway of an existing road. It is usually sited on the left side of the road, preferably between the kerbs and the parking lane. Some form of physical barrier or pavement markings defines the corridor set aside for the cyclists and route markings are necessary to define the route and reduce potential conflicts. However, at crossings and intersections, this kind of cycle track ceases as a separate mode and conflicts may occur with other forms of movement.

8.10.3 An exclusive motorcycle track is a complete separate right-of-way established for the sole use of cyclists. It differs from the restricted cycle track in that it normally has a wide right-of-way and is not developed from existing carriageway of a wide road and it separates the cyclists from other motorists. It helps to separate conflicts at crossings and intersections with the provision of underpasses and other related facilities.

8.10.4 In areas, where there is usually a high proportion of motorcyclist, the volume may be so substantial as to affect the smooth flow of traffic. In such instances, the provision of separate and exclusive cycle lanes should be considered. The warrants for determining the need for an exclusive cycle lane are:

- when total volume of traffic exceeds the provided lane capacity, and
- when volume of motorcycles exceeds 20% of the total volume of traffic.

8.11 Emergency Escape Ramps

8.11.1 General

The emergency escape ramp is desired at appropriate location to provide a location for out-of-control vehicles, particularly trucks, to slow and stop away from the main traffic stream.

If the conditions indicate the need for more than one, should be located wherever grades are of steepness and length that present a substantial risk of runaway trucks and topographic conditions permit construction.

NOTE Out-of-control vehicles are generally the result of a driver losing braking ability either through overheating of the brakes due to mechanical failure or failure to downshift at the appropriate time. Each grade has its own unique characteristics. Highway alignment, gradient, length, and descent speed contribute to the potential for out-of-control vehicles.

The principal factor in determining the need for an emergency escape ramp should be the safety of the other traffic on the roadway, the driver of the out-of-control vehicle, and the residents along and at the bottom of the grade. An escape ramp, or ramps if the conditions indicate the need for more than one, should be located wherever grades are of a steepness and length that present a substantial risk of runaway trucks and topographic conditions will permit construction.

Crash experience (or, for new facilities, crash experience on similar facilities) and truck operations on the grade combined with engineering judgment are frequently used to determine the need for a truck escape ramp. Often the impact of a potential runaway truck on adjacent activities or population centres will provide sufficient reason to construct an escape ramp. For existing facilities, an escape ramp should be provided as soon as a need is established.

8.11.2 Design Considerations

The design and construction of effective escape ramps involve a number of considerations as follows:

- a) To safely stop an out-of-control vehicle, the length of the ramp should be sufficient to dissipate the kinetic energy of the moving vehicle.
- b) The alignment of the escape ramp should be tangent or on very flat curvature to minimize the driver's difficulty in controlling the vehicle. Escape ramps should exit to the right of the roadway.
- c) The width of the ramp should be adequate to accommodate more than one vehicle because it is not uncommon for two or more vehicles to have need of the escape ramp within a short time. A minimum width of 8 m may be all that is practical in some areas, though greater widths are preferred. Desirably, a width of 9 to 12 m would more adequately accommodate two or more out-of control vehicles.
- d) To assist in decelerating the vehicle smoothly, the depth of the arrester bed should be tapered from a minimum of 75 mm at the entry point to the full depth of aggregate in the initial 30 to 60 m of the bed. As a vehicle rolls upgrade, it loses momentum and will eventually stop because of the effect of gravity.
- e) To determine the distance needed to bring the vehicle to a stop with consideration of the rolling resistance and gradient resistance, the following equation may be used:

$$L = \frac{V^2}{254(R - G)}$$

where

L is length of arrester bed, m

V is entering velocity

R is rolling resistance, expressed as equivalent percentage gradient divided by 100

G is percent grade divided by 100

The final speed for one section of the ramp is subtracted from the entering speed to determine a new entering speed for the next section of the ramp and the calculation repeated at each change in grade on the ramp until sufficient length is provided to reduce the speed of the out-of-control vehicle to zero. Figure 18 shows a plan and profile of an emergency escape ramp with typical appurtenances.

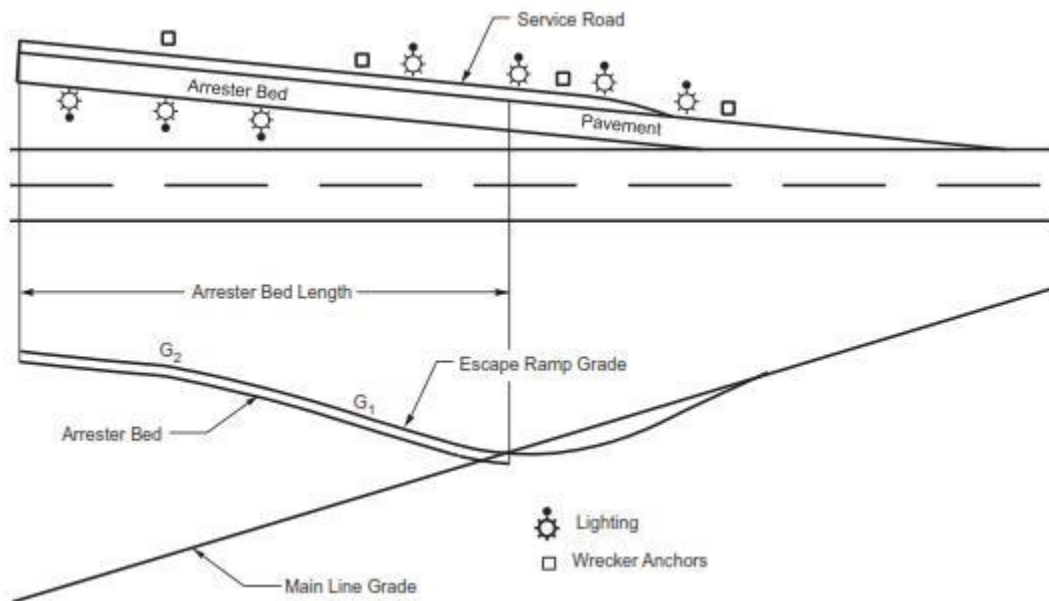

Figure 18 —Typical emergency escape ramp

8.11.3 Brake-Check Areas

Turnouts or pull-off areas at the summit of a grade can be used for brake-check areas or mandatory-stop areas to provide an opportunity for a driver to inspect equipment on the vehicle and check that the brakes are not overheated at the beginning of the descent. An elaborate design is not needed for these areas. A brake-check area can be a paved lane behind and separated from the shoulder or a widened shoulder where a truck can stop. Appropriate signing should be used to discourage casual stopping by the public.

9 Intersections

9.1 General

9.1.1 An intersection is an important part of a road network because the safety, speed, efficiency, and cost of operation of vehicles on and capacity of the network are greatly influenced by the effectiveness of its intersections. Intersections vary in complexity from a simple intersection, which has only two roads crossing at a right angle to each other, to a more complex intersection, at which three or more roads cross within the same area.

9.1.2 The highways intersection can be of the following categories:

- a) **At-grade intersections**, which do not provide for the flow of traffic at different levels of elevation
- b) **Grade separated without ramps**, which provide spatial separation between the crossing movements but do not make provision for turning movements
- c) **grade separated with ramps (interchanges)**. The principal difference between interchanges and other forms of intersection is that, in interchanges, crossing movements are separated in space whereas, in the other forms of intersection, they are separated in time

9.2 The Choice of an Intersection Type

9.2.1 All intersections shall be compatible with the operating conditions of the type of road on which it is installed with a view to apply grade separation, if warranted. Furthermore, the type of intersection must be compatible with the specific conditions of the site and its operation including traffic volume, closeness to a built-up area, transition between two types of road, and safety problems.

9.2.2 The choice of the right type of intersection shall be made based on the capacity required, safety, environment and uniformity, spatial limitations, topographical conditions and construction and maintenance costs, road user costs. In the case of a new construction, the decision will frequently be based on general knowledge about how a given type of intersection affects, for instance, the number of accidents and delays while at a site with an existing junction, a safety diagnosis is an essential basis for decision-making.

Figure 19 shows a typical approach to selection of appropriate intersection type.

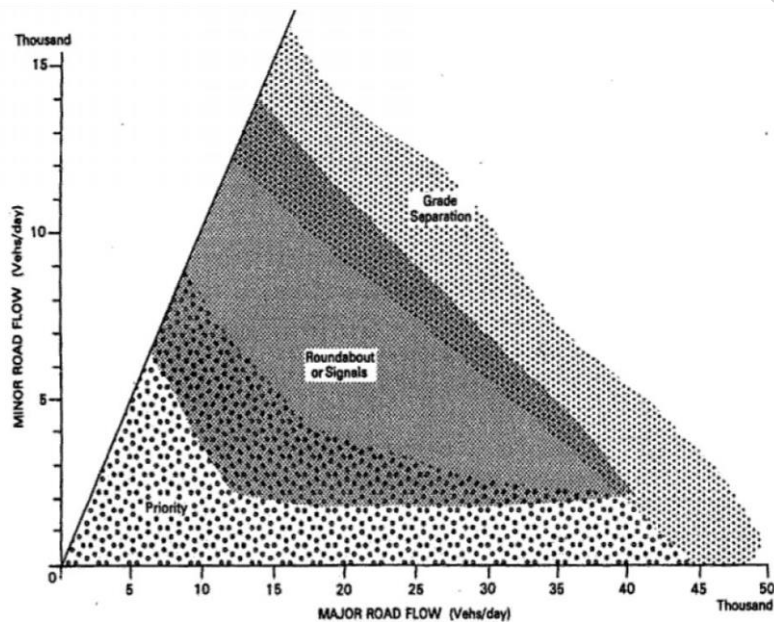

Figure 19 —Types of intersections appropriate to different traffic flows

9.2.3 Many factors enter into the choice of type of intersection and the extent of design of a given type, but the principal controls are the design-hour traffic volume, the character or composition of traffic, and the design speed. In general, traffic service, highway design designation, physical conditions, and cost of right-of-way are considered jointly in choosing the type of intersection.

9.2.4 The selection can be performed through two-steps procedure for selection of at-grade intersection; these are selection of intersection category (priority or control) and selection of intersection type and is based on the following assumptions

- Priority intersections can be safe and give sufficient capacity for certain traffic volumes and speed limits
- If a priority intersection is not sufficient for safety and capacity, the major road traffic must also be controlled
- Depending on location, traffic conditions and speed limits, different types of priority or control intersection should be selected

9.3 Basic At-Grade Intersection Elements

9.3.1 General

The intersections shall be designed with the main objective of ensuring effective utilization of the road network and to reducing the severity of potential conflicts between vehicles or between vehicles and pedestrians, while facilitating the necessary manoeuvres.

The basic types of at grade intersection are:

- a) **three-leg intersection** (T-junction), which generates six vehicle conflict points and ten vehicle-pedestrian conflict points;
- b) **four-leg or cross intersection**, which has twenty-four vehicle conflicts and twenty-four vehicle-pedestrian conflict points; and
- c) **multi-leg intersection**.

9.3.2 The Distance between Intersections

9.3.2.1 The spacing of intersections impacts significantly on the operation, level of service and capacity of a roadway. For safe and efficient traffic flow, intersections should not be placed too close together. Designers seldom have influence on the spacing of roadways in a network as it is largely predicated by the original or developed land use.

9.3.2.2 The proper intersection spacing, particularly for signalized intersections, is critical for providing coordinated signal timing, optimal timing progression for two-way movements should allow travel time between intersections to be about half of the cycle length.

9.3.2.3 The signal spacing shall be at least 400 m in urban areas and 800 m in suburban areas for optimum two-way progression, and for unsignalised intersections the minimum distance should be at least $10 \cdot V_D$ meters.

9.3.3 Location

The intersection shall be located in appropriate locations to ensure their safety. It is suggested that where possible, intersections should not be located on a horizontal curve if possible or near a crest vertical curve, due to restrictions on sight distance.

9.3.4 Angle

9.3.4.1 The angle of intersection is important to operations. A right angle intersection provides the most favourable conditions for intersecting and turning traffic movements. Specifically, a right angle (90°) provides (a) the shortest crossing distance for motor vehicles, bicycles, and pedestrians, and (b) sight lines which optimize corner sight distance and the ability of drivers to judge the relative position and speed of approach vehicles.

9.3.4.2 Minor deviations from right angles are generally acceptable provided that the potentially detrimental impact on visibility and turning movements for large trucks can be mitigated. However, large deviations from right angles may decrease visibility, hamper certain turning operations, and will increase the size of the intersection and therefore crossing distances for bicyclists and pedestrians.

9.3.4.3 This makes vehicle and pedestrian time in the area conflicting with other traffic streams increase so delays and collisions increase. In addition, the paved area—and therefore construction and maintenance cost—will increase and these effects increase dramatically with angles less than 60 or greater than 120.

9.3.4.4 Several retrofit improvement strategies exist for treating existing or proposed intersections with unfavourable angles. One (minor leg) or both roads could be realigned with horizontal curves to create a more

favourable angle. In some cases, one intersection can be made into two, creating an offset intersection. Another option is to use islands to guide drivers and pedestrians safe manoeuvre through the intersection and reduce the paved area.

9.3.4.5 The angle of existing intersections should be checked for possible implementation of retrofitting improvement strategies, if necessary.

9.3.5 Warrants for Turning Lanes

9.3.5.1 Turning lanes are provided to give room for left-turning or right-turning vehicles to decelerate before their turns and/ or to queue while waiting to turn. They are particularly effective at reducing delay and collisions by getting those vehicles out of the way of through vehicles.

9.3.5.2 When designing an intersection, left-turning traffic should be removed from the through lanes, whenever practical. Therefore, provision for left turn lanes has widespread application. Ideally, left-turn lanes should be provided at driveways and street intersections along major arterial and collector roads wherever left turns are permitted.

9.3.5.3 Left turn facilities should be established on roadways where traffic volumes are high enough or safety considerations are sufficient to warrant them. They are often needed to ensure adequate service levels for the intersections and the various turning movements.

9.3.5.4 Table 29 presents proposed guide to traffic volumes where left turn lanes should be considered on two-lane highways. For the volumes shown, left turns and right turns from the minor street can be equal to, but not greater than, the left turns from the major street. In the case of the double left turn lanes, a capacity analysis of the intersection should be permitted to determine what traffic controls are needed in order for it to function properly.

Table 29 — Guide for left-turn lanes on two-lane highways

Opposing volume (veh/h)	Advancing volume (veh/h)			
	5% left turns	10% left turns	20% left turns	30% left turns
60 km/h operating speed				
800	330	240	180	160
600	410	305	225	200
400	510	380	275	245
200	640	470	350	305
100	720	515	390	340
80 km/h operating speed				
800	280	210	165	135
600	350	260	195	170
400	430	320	240	210
200	550	400	300	270
100	615	445	335	295

100 km/h operating speed				
800	230	170	125	115
600	290	210	160	140
400	365	270	200	175
200	450	330	250	215
100	505	370	275	240

9.3.6 Grades

9.3.6.1 Intersections require less steep grade to avoid hampering traffic operations at intersections. Steep downgrades on an intersection approach increase stopping distances and make turning more difficult. Steep upgrades on an intersection approach make idling difficult for vehicles with manual transmissions and make acceleration slower for all vehicles, which in turn increases necessary gap sizes and sight distances for crossing and turning movements.

9.3.6.2 It is recommended that Intersection shall at locations that have grades of less than 4%.

9.4 Grade Separations and Interchanges

9.4.1 General

9.4.1.1 Grade separation shall be used to accommodate high volumes of intersecting traffic safely and efficiently through the arrangement of one or more interconnecting roadways. A system of interchange shall be used to provide for the movement of traffic between the roadways.

9.4.1.2 For Interstate highways, interchanges shall be provided between all intersecting Interstate routes, between other selected access controlled highways and at other selected public highways to facilitate distribution of traffic. The design of its design shall be considered in conjunction with adjacent interchanges or grade separations on the project as a whole to provide uniformity and route continuity to avoid confusion in driver expectancy.

9.4.1.3 Each interchange shall provide for all traffic movements. The type and design of grade separations and interchanges are influenced by many factors such as highway classification, character and composition of traffic, design speed and degree of access control. These controls plus signing needs, economics, terrain and right-of-way are of great importance in designing facilities with adequate capacity to safely accommodate traffic demands.

9.4.1.4 Interchanges vary in type from single ramps connecting local streets to complex and comprehensive design layouts involving the intersection of multiple highways. The basic interchange configurations are indicated in Figure 20.

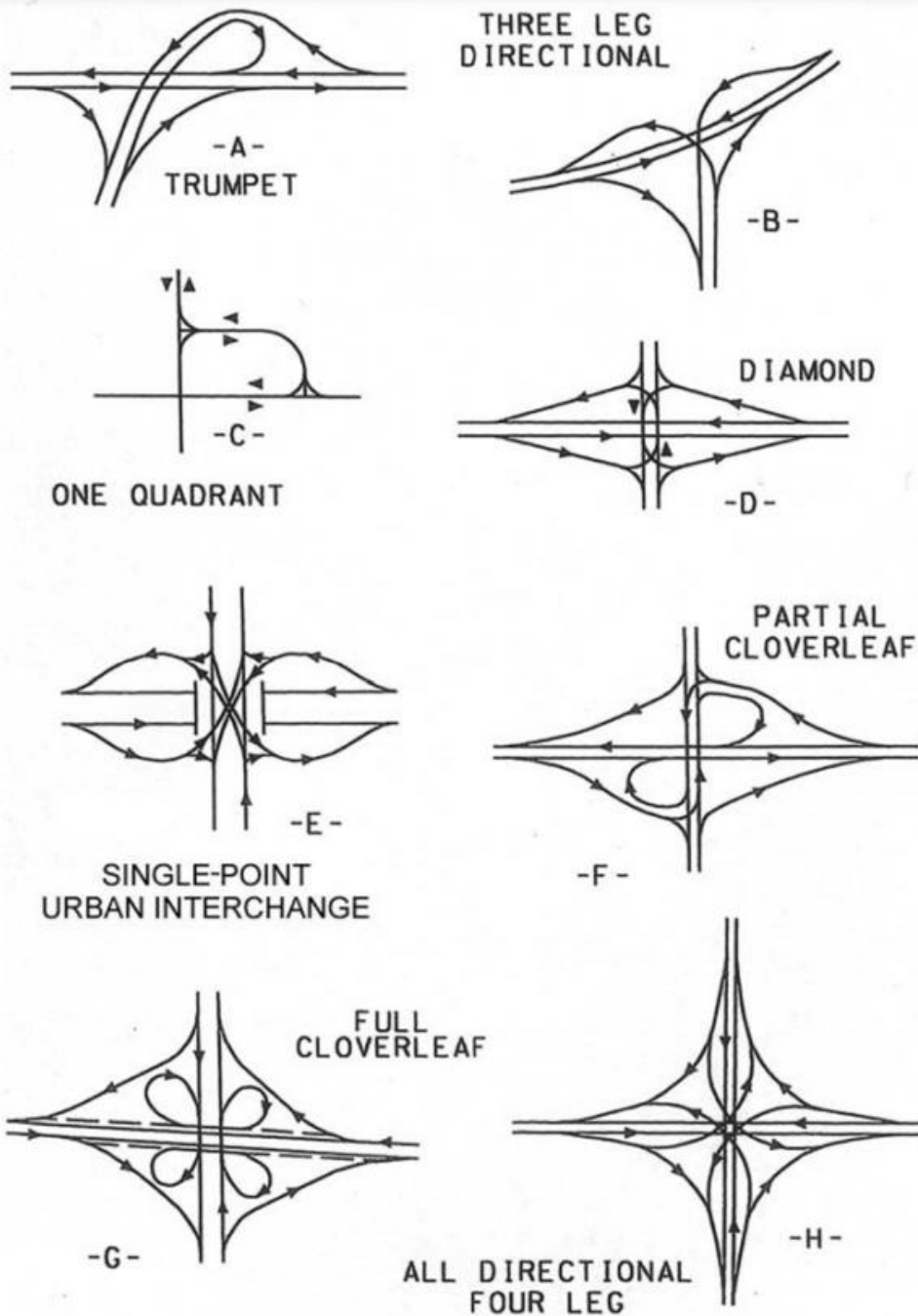

Figure 20 — Interchange Configurations

9.4.1.5 An important element of interchange design which influences the efficiency, safety and capacity attained is the size and arrangement of ramps that connect two or more legs at an interchange.

9.4.2 Warrants for Grade Separations and Interchanges

9.4.2.1 The justification of an interchange at a given location is difficult due to the wide variety of site conditions, traffic volume, highway types and interchange layouts. The following six warrants should be considered together with undertaking of benefit cost analysis for determining if an interchange is justified at a particular site:

- a) **Design designation:** The design designation of a roadway is one method used to help decision-makers decide whether or not grade-separated interchanges are justified. Once a controlled access facility has been designated on the major road, an interchange may be warranted for a crossing road based on the anticipated demand for access to the minor road. If a given route has been designated as a freeway corridor, then all conflicting approaches to the freeway must be evaluated individually. In other words, it must be determined whether a given crossroad should be terminated, rerouted, or provided with grade separation. This determination is based on the importance of the crossroad. A minor or local road would typically be terminated, or rerouted, due to their nature of having low traffic volumes. If an arterial or a collector crosses the freeway with significant traffic volumes, a grade separation may be provided. Since this determination is based, in part, on traffic volumes, a method for estimating the amount of traffic that justifies grade separation needs to be evaluated in more detail. The justification for implementing grade separations based solely on the design designation of a roadway is generally applicable in the case of freeway corridors only. If the arterial road has not been designated as a freeway corridor and does not conflict with any existing freeways, this warrant would not be applicable. Of course this does not imply that the designation of the arterial roadway cannot be changed in the future. In fact the alteration of an arterial road to a highflow arterial may merely be a stepping stone in the design evolution from a simple arterial street to a freeway. Thus, an intersection that might warrant only traffic signal, if considered as an isolated case, will warrant a grade separation or interchange when considered as part of a freeway.
- b) **Reduction of bottlenecks or spot congestion:** An interchange may be warranted if the congestion at an at grade intersection is intolerable, and the intersection cannot be redesigned to accommodate the traffic volumes. Intersections that cannot provide sufficient capacity for roadways with significantly large volumes will inevitably experience excessive levels of congestion on one or more of its approaches. Such intersections are typically classified as bottlenecks. A single congested intersection of an arterial network can easily affect nearby intersections or driveways if long queues of vehicles are allowed to spillback. Therefore, it is essential to minimize the delay that results from heavy congestion through the use of at-grade treatments. Surface treatments may include signal optimization, channelization, and pavement re-striping. If a bottleneck cannot be eliminated through simple means, then grade separation may be justified.
- c) **Safety improvement:** For intersections where the crash rate is significantly high, grade separation may be justified. This is because more crossing or turning conflicts are encountered at surface intersections, and grade separations remove a significant portion of these vehicle conflicts. A cost-effective analysis may justify the expense of an interchange solely on the basis of safety benefits so that the likelihood of traffic crashes can be significantly decreased.
- d) **Site topography:** The topography at some locations may be such that an interchange can be constructed at less than or comparable to the cost of an at-grade intersection. This is due primarily by the design constraints associated with vertical alignment.
- e) **Road-user benefits:** An interchange may be warranted where the road user costs such as fuel and oil usage, wear on tires, repairs, delays, crashes that results from speed changes, stops, and waiting are significantly reduced when compared to at-grade intersections. The relation of road-user benefits to the cost of improvement indicates an economic warrant for that improvement. Comparison of benefit cost ratios for design alternatives is an important factor in determining the type and extent of improvement to be made.
- f) **Traffic volumes:** This may be the most tangible of any interchange warrant. Although a specific volume of traffic at an intersection cannot be completely rationalized as the warrant for an interchange, it is an important guide, particularly when combined with the traffic distribution pattern and the effect of traffic behaviour. However, volumes in excess of the capacity of an at-grade intersection would certainly be a warrant.

9.4.2.2 Not all warrants for grade separations are included in the warrants for interchanges. Additional warrants for grade separation include grade separation that would be installed at:

- a) Locations where the termination of local roads and streets is not feasible because of limitations in freeway right-of-way

- b) Areas that are not accessible by means of frontage roads or other sources of access.
- c) Eliminate a railroad-highway grade crossing
- d) Locations with unusual concentrations of pedestrian and/or bicycle traffic for instance, a city park developed on both sides of a major arterial
- e) Other areas with routine pedestrian and/or bike traffic, especially in school zones
- f) Mass transit stations that require access because of their location within the confines of a major arterial
- g) Places with free-flow characteristics of certain ramp configurations and completing the geometry of an interchange.

benefits attributable to operational and design improvements made to arterial intersections.

9.4.2 Spacing

9.4.2.1 If an interchange is warranted for any of the listed reasons, interchange spacing is an additional consideration in the decision-making process. Interchange spacing has a pronounced effect on freeway operations. In areas of concentrated urban development, proper spacing usually is difficult to attain because of traffic demand for frequent access. Minimum spacing of arterial interchanges (distance between intersecting roads with ramps) is determined by weaving volumes, ability to sign, signal progression, and lengths of speed-change lanes.

9.4.2.2 The rule of thumb for minimum interchange spacing is 1.5 km in urban areas, and 3.0 km in rural areas (between freeway-to-freeway interchanges and local roads interchanges). In urban areas spacing of less than 1.5 km may be developed by grade-separated ramps or by adding collector-distributor roads.

9.5 Railroad – Highway Crossing

9.5.1 A railroad-highway crossing, like any highway-highway intersection, involves either a separation of grades or a crossing at-grade. The geometrics of a highway and structure that involves the overcrossing or under-crossing of a railroad are substantially the same as those for a highway grade separation without ramps. The horizontal and vertical geometrics of a highway approaching a railroad grade crossing should be constructed in a manner that facilitates drivers' attention to roadway conditions.

9.5.2 Some of the safety, operational and emergency issues associated with an at grade crossing include traffic and emergency response may periodically be disrupted by train traffic. Operational issues with this type of crossing may be worsened as traffic volumes increase over time. Intersections handling a high volume of traffic and pedestrians (and possibly railroads) limit the capacity of the approaching roads.

9.5.3 Grade-separating these conflict points allow an uninterrupted flow of traffic while also eliminating the safety threat posed by trains, pedestrians, or other vehicles. Three primary roadway improvement objectives are accomplished using grade separated intersections; increased capacity and uninterrupted flow, increased safety, and reduced vehicle-train conflict and delay.

9.5.4 The decision to grade separate a highway-rail crossing is primarily a matter of economics. Investment in a grade separation structure is long-term and impacts many users. Such decisions should be based on long-term, fully allocated life-cycle costs, including both highway and railroad user costs, rather than on initial construction costs. Such analysis should consider:

- a) Eliminating train/vehicle collisions (including the resultant property damage and medical costs and liability).
- b) Savings in highway-rail grade crossing surface and crossing signal installation and maintenance costs.

- c) Driver delay cost savings.
- d) Costs associated with providing increased highway storage capacity (to accommodate traffic backed up by a train).
- e) Fuel and pollution mitigation cost savings (from idling queued vehicles).
- f) Effects of any “spillover” congestion on the rest of the roadway system.
- g) Benefits of improved emergency access.
- h) Potential for closing one or more additional adjacent crossings.
- i) Possible train derailment costs.

10 Speed Management

10.1 Speed Control Measures

10.1.1 Speed management encompasses a range of measures aimed at balancing safety and efficiency of vehicle speeds on a road network. It aims to reduce the incidence of driving too fast for the prevailing conditions, and to maximize compliance with speed limits. Speed management aims to reduce the number of road traffic crashes and the serious injury and death that can result from them. There are many tools available for effective speed management. They include appropriate speed limits, engineering treatments, effective enforcement of speed limits by police and the use of extensive public information and education programmes to encourage compliance with speed limits.

10.1.2 Numerous practices have been implemented in urban areas to reduce speeds:

- a) Pre-warnings: typically lines on the pavement with (rumble strips) or without punishment (lines and traffic signs)
- b) Gates: typically different pavement colour or structures that indicate transition between traffic environments, often augmented with signs and landscaping
- c) Narrowings: typically the available roadway width is reduced to narrower lane widths with the addition of islands, by eliminating one lane in two-lane roads or by using wider edge markings
- d) Humps and tables: with varied profiles including circular, sinusoidal, dome-shaped, or trapezoidal cross-sections and varied lengths depending upon the desired speed reduction
- e) Raised areas: typically a trapezoidal hump with extended length to allow for longer vehicles to have all wheels on them
- f) Staggering: typically a lane is shifted over
- g) Chicanes: typically extensions of the curb at intersections to reduce approach lane widths
- h) Islands: typically raised elements along the centreline of the roadway to shelter pedestrians and ease street crossing
- i) Cushions: typically square humps in each travel lane

10.2 Speed Humps

10.2.1 Road humps are not recommended to be used on International Trunk Roads. They may be used on National Trunk Roads and Regional Roads where proven to be absolutely necessary. They are suitable for

residential areas but are not acceptable and should not be used on national roads such as Trunk and Regional roads.

10.2.2 There are two main types of road humps:

- a) **circular**, which are intended for traffic speed reduction only, and;
- b) **flat-topped humps**, which are intended for speed reduction and for use as a pedestrian crossing.

Table 30a and Table 30b gives the recommended standards for design of circular speed hump and of flat-topped speed hump

Table 30a — Detailed design of circular speed hump

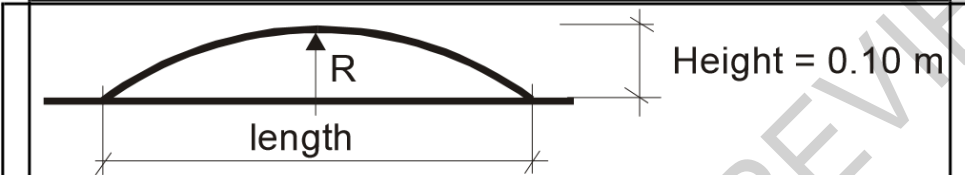

Vehicle speed(km/h)	Radius (m)	Length (m)
20	11	3.0
25	15	3.5
30	20	4.0
35	31	5.0
40	53	6.5
45	80	8.0
50	113	9.5
55	180	12.0

Table 30b — Detailed design of flat – topped speed hump

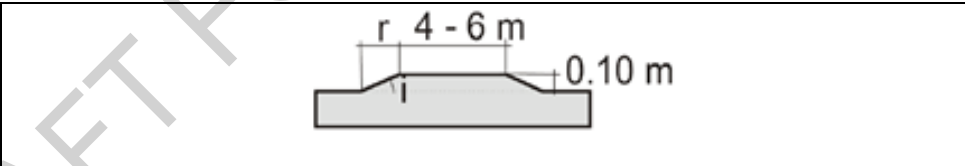

Car (truck) speed level (km/h)	Ramp length r (m)	Grade i (%)
30 (10)	1.0	10
35 (15)	1.3	7.5
40 (20)	1.7	6
45 (25)	2.0	5
50 (30)	2.5	4
(35)	3.3	3
(40)	4.0	2.5

10.3 Rumble strips

10.3.1 Rumble strips are transverse strips across the road used to alert and warn drivers with a vibratory and audible effect before a hazard such as a sharp bend, an intersection or a lower speed limit at the entry to a trading centre. Warning signs are not normally needed when the strips are built to the specifications given below. However, rumble strips create disturbing noises and can cause vibration problems on soft ground. Thus, it is recommended to avoid installing them near places such as houses, schools, and hospitals.

10.3.2 Rumble strips can be used in such situation as, before a local speed limit, at an approach to a dangerous intersection, before a sharp bend, before a hump.

10.3.3 The design of rumble strips may be done in either of the following two options. This first option recommends the following principles as they are presented on Figure 21:

- a) Rumble strips should normally be in groups of 4 strips
- b) The height of the strips shall be no more than 10 – 15 mm
- c) One set of rumble strips is usually enough within 50km/h sections
- d) The last or only strip should be located 30 to 50 m before the hazard
- e) Pre-warning sets can, if used, be located 20 to 80 m before the hazard depending on speeds
- f) Rumble strips should preferably have white thermoplastic lines across the top for better visibility
- g) Strips should continue across the full width of the carriageway, including the shoulders but be terminated so that they do not interfere with drainage.

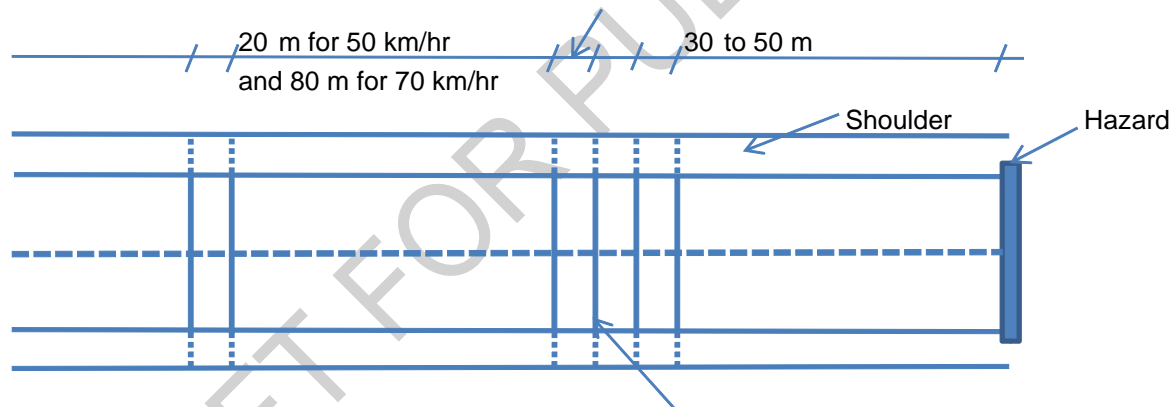

Figure 21 — Design of rumble strips option one

10.3.4 The design of rumble strips by option two recommend the following principles and the typical illustration is given on Figure 22. The rumble strips should have rounded profile, a maximum height of 15 mm, and installed in groups of four extending the full width of the carriageway including the shoulders. The standard layout comprises of three groups of strips, the first pair 90 m apart and the second pair 60 m apart. Where approach speeds are less than 80 km/hr, the number of groups can be reduced to two or one. The last group should be 25-50 m in advance of the hazard. It is further recommended that the spacing and width of rumble strips should be 200 m and rumble strips should not be used on bends with radius of less than 1, 000 m.

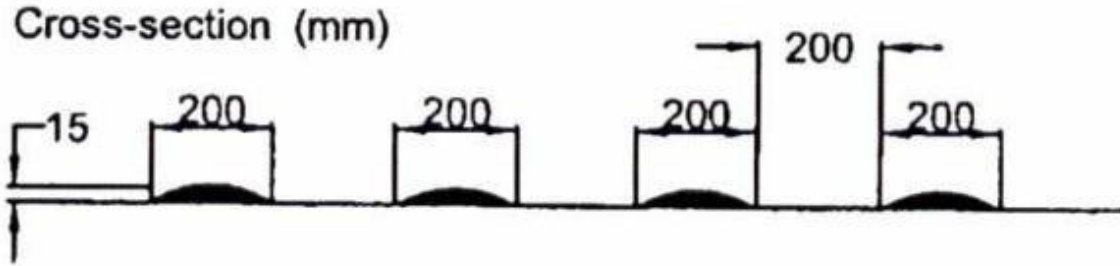

Figure 22 — Design of rumble strips option two

10.3.5 Other speed control measures other than the speed humps and rumble strips should be tried on major roads to reduce vehicle speeds. Such measures may include narrowings, raised zebra crossings, and use of combination of measures.

11 Pedestrian and Cyclists Facilities/ NMT Facilities

11.1 Pedestrians Facilities

11.1.1 Pedestrian facilities include sidewalks, crosswalks, traffic control features, bus stops or other loading areas, sidewalk on grade separations, and the stairs, escalators, or elevators related to these facilities, and curb cuts (depressed curbs and ramped sidewalks) and ramps for older walkers and persons with mobility impairments.

11.1.2 The pedestrian facility shall provide a network of pedestrian routes and crossing facilities that is convenient to use and avoids conflicts with vehicular traffic.

11.2 Shoulders and Footways

11.2.1 The shoulder shall be at least 1.5 m wide, though 1 m is just acceptable if there are constraints. The surface must be well drained and be as smooth as the traffic lanes, if not, pedestrians may prefer to walk in the traffic lane.

11.2.2 The height of barrier kerb shall be 100 – 200 mm high to deter vehicle from encroaching sidewalks.

11.2.3 **In situation such as** high-speed and / or high volume roads, letting pedestrians use the shoulders is not entirely satisfactory, as there is nothing to protect the pedestrian from speeding traffic. In these situations, it is preferable to provide a separate footway several metres beyond the edge of the shoulder – and separated from it by a grass strip.

Some criteria for the provision of footways are given in Table 31. However, but these should be used with caution – In some circumstances footways can be justified at lower pedestrian flows.

Table 31 — Criteria for provision of footways

Location of footway	Average daily vehicle traffic	Pedestrian flow per day	
		Speed limit of 60 – 80 km/h	Speed limit of 80 – 100km/h

One side only	400 to 1,400	300	200
	> 1,400	200	120
Both sides	700 to 1,400	1,000	600
	> 1,400	600	400

11.2.4 Standard footway widths shall be as follow:

- a) Absolute minimum: 1 m (two persons cannot pass each other)
- b) Desirable minimum: 1.8 m (two persons can pass each other closely)
- c) Light volume: 2.25 m (two persons can pass each other comfortably)
- d) Heavy volume: 3.5 m + (space for three persons)

11.2 Pedestrian Bridges and Underpasses

11.2.1 The minimum height for underpasses shall be 2.3 for short (< 15 m) and 3.0 m for long (> 15 m) underpasses.

11.2.2 The recommended flights of stairs (between landings) is limited to 12 steps and 9 steps where there are significant numbers of disabled persons.

11.2.3 The headroom under pedestrian bridges shall be 5.5m above the carriageway surface.

11.3 Cycle Facilities

11.3.1 The conventional view is that cyclists in rural areas can use the shoulders, and this is acceptable provided that the combined volume of pedestrians and cyclists is low (<400 per day) and the shoulder is at least 1.5 m wide. However, with heavier flows, and especially if there is high-speed traffic or a high proportion of heavy goods vehicles, it will be better to provide a separate cycleway or a combined cycleway and footway.

11.3.2 The design manuals for widths for cycle facilities are given in Table 32 and clearances to wall, fence, barrier or other fixed object for various speed limits are given in Table 33.

Table 32— Widths for cycle facilities

Type	Minimum width (m)	Standard width (m)	Width for heavy usage (m)
Cycleway (separate from carriageway)	2.0	2.5	3.5
Combined cycleway and footway	2.0	3.0	4.5
Cycle lane (one way)	1.5	2.0	2.5

Table 33 — Clearances for cycle facilities

Type	Recommended clearance [m]
Minimum overhead clearance	0.50
Clearance to wall, fence, barrier or other fixed object	0.50
Clearance to unfenced drop-off, e.g. embankment, river, wall	1.0

Minimum clearance to edge of traffic lane for speed limit of:	
50 km/h	0.50
80 km/h	1.00
100 km/h	1.50

11.3.3 It is also recommended to provide separate cycleway or combined cycleway and footway if there is high-traffic and the combined flow of pedestrians and cyclists is more than 400 per day.

11.3.4 Cycleways shall have a smooth surface with good skid resistance.

12 Traffic Control Devices and Other Facilities

12.1 General

Road furniture and safety represents a collection of marginal elements intended to improve the driver's perception and comprehension of the continually changing appearance of the road. Such elements include traffic signs, road markings, traffic signals marker posts, kilometre posts and road reserve marker posts.

12.2 Marker Posts

The maker posts are intended to make drivers aware of potential hazards. They are to be sited at 0.25 m outside the edge of the shoulder.

12.3 Kilometre Posts

12.3.1 These are blocks or pillars of concrete set up beside major roads to show distances from that point to town centres or major settlements along the road. They show the distances to the destination and that of the origin placed in such a way that the road user will only immediately see the distance to the destination.

12.3.2 The kilometre posts are installed along the whole road at an interval of distance of 5 kilometres from each other. Also the posts should be placed in stagger thus forming a 10 km interval on each side of the road.

12.4 Road Reserve Marker Posts

12.4.1 Demarcation of the boarder of the road reserve shall be done by proper placement of road reserve markers posts to limit the unauthorised access tend to develop within the road reserve area.

12.4.2 The posts are recommended to be erected on both sides of the road at intervals of 100 m from each other when traversing inhabited areas and at 300 m on other areas. Whenever new villages are formed along the roads, additional road reserve marker posts should be erected to meet the 100 m interval.

12.5 Rest Areas

There are three categories three types of rest areas: major, minor and truck parking bays. Having taken these requirements into account, we recommend that the following requirements should be taken into account when planning for rest areas.

12.5.1 Planning for Rest Areas

12.5.1.1 A detailed Rest Area Strategy Plan should be developed for all mobility roads and significant freight routes. Three categories of rest areas should be reflected in the Rest Area Strategy Plans developed by road agencies for all major highways and significant freight routes:

- a) **Major Rest Areas:** These areas are designed for long rest breaks, offering a range of facilities and separate parking areas for heavy and light vehicles. These are designed to allow drivers to take rest and sleep breaks required under current driving hours regulations.
- b) **Minor Rest Areas:** These areas are designed for shorter rest breaks, and at a minimum should provide sufficient parking space for both heavy and light vehicles. While it is not anticipated that these stops will be used for long rest breaks/sleep opportunities, separate parking areas for heavy and light vehicles may be required at some locations.
- c) **Truck Parking Bays:** These areas are primarily designed to allow drivers of heavy vehicles to conduct short, purpose-based stops including load checks, completing logbooks and addressing associated operational needs.

12.5.1.2 On a given highway or freight route, a mix of the three rest area categories shall be provided. In the development of new rest areas, the category and size of a selected rest area shall flow from the Rest Area Strategy Plan developed for the route. Selection shall be based on the mix and volume of traffic, the perceived demand for the rest area and the availability of existing rest opportunities, commercial service centres or nearby towns.

12.5.2 Spacing Intervals

12.5.2.1 Intervals between rest areas shall depend on the category of rest area selected, the volume and mix of traffic and the demand for parking and rest opportunities identified in the Rest Area Strategy Plan for a given highway or route. However, as a general rule:

- a) **Major Rest Areas** shown in Figure 23, shall be located at maximum intervals of 100 – 120 km,
- b) **Minor Rest Areas** shown in Figure 24 shall be located at maximum intervals of 50 – 60 km, and
- c) **Truck Parking Bays** shall be located at maximum intervals of 30 – 40 km.

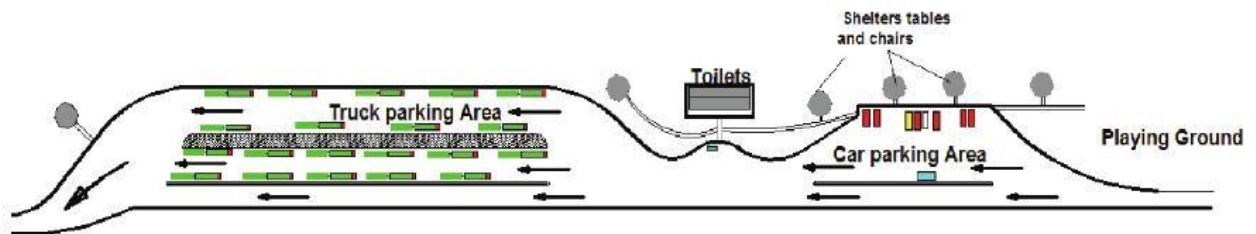

Figure 23 — Typical layout design with truck and car parking of major rest areas –front to rear parking design

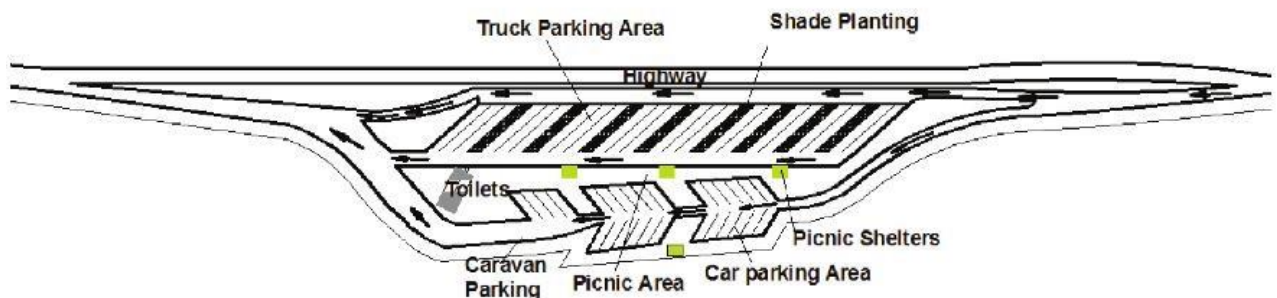

Figure 24 — Typical layout design with truck and car parking of minor rest areas –angle parking design

12.5.2.2 Differences in traffic volume and rest area demand will impact on the spacing of rest areas, and the number and size of parking spaces provided. Spacing may need to be reduced on highly trafficked routes where demand is evident.

12.5.2.3 On mobility roads it is recommended that Rest Areas, and especially commercial service centres, are located at mid-block locations on both carriageways, offering equal stopping opportunities in advance of sites servicing opposing traffic. Where duplicate rest areas are not available (due to insufficient funding or demand), facilities should be staggered in the direction of approaching traffic to discourage cross median vehicular movements and to deter drivers from parking on shoulders and walking across the carriageway to access facilities.

12.5.2.4 On major, undivided highways it is recommended that Rest Areas and Truck Parking Bays are provided on both sides of the road. This is particularly important in order to eliminate the need for heavy vehicles to turn across oncoming traffic to enter a rest area on the opposite side of the road.

12.5.3 Proximity to a Town

The rest areas shall be located to promote the use of town facilities (including toilet and shower amenities and the purchase of food and fuel), where they are provided and accessible on a given route. Where the traffic volume and demand warrants, consideration should be given to providing a Truck Parking Bay within 20km to 30km of a township to allow drivers the opportunity to take a rest break and check vehicle loads.

12.5.4 Location

12.5.4.1 In planning the location of new rest areas and the upgrading of existing rest areas, the status and physical characteristics of the environment of a potential or existing site must be examined. Issues associated with topography, landmarks or scenic viewpoints and environmental qualities should be considered. The location of watercourses and utilities, the proximity to major road interchanges and the need for additional land should also be considered.

12.5.4.2 Whilst it is most desirable to comply with the siting requirements summarised above, there are many other features that influence the location of rest areas. It must be practicable to provide a rest area at a particular site in relation to factors such as topography, availability of utilities, environmental considerations, other road infrastructure, and traffic operations and safety.

12.5.5 Proposed Layout

The rest areas shall be designed to provide suitable facilities in an environment that promotes effective and safe rest and/or sleep opportunities, and to ensure that there is adequate provision for vehicles and pedestrians to move safely within the site.

The number of spaces provided at a given rest area site shall be based on traffic volume and expected demand. As a general rule:

- a) major rest areas should provide sufficient parking space for at least 20 vehicles,
- b) minor rest areas should provide parking for up to 10 vehicles, and
- c) truck parking bays should provide sufficient area to accommodate at least four to five heavy vehicles at any one time.

12.5.6 Pedestrian Access and Visibility

Rest areas and service centres shall be designed to ensure that potential conflict between vehicles and pedestrians is minimised, and that any necessary interaction occurs at a very low speed.

12.5.7 Speed

The design speed for vehicle travel within a rest area shall be considered in conjunction with the type of rest area, the location within the area and environmental conditions.

12.5.8 Access

When designing rest area layouts, consideration should be given to the provision of safe and effective access to the facility required for different standards of roads. Features including acceleration and deceleration lanes, entrance and exit ramps and slip lanes need to be designed.

12.5.9 Minimum Facilities

12.5.9.1 The minimum facilities that shall be provided at major and minor rest areas are:

- a) All weather pavements, with sealed pavements for access and egress roads/ramps.
- b) Shade.
- c) Rubbish bins.
- d) Separate parking for heavy and light vehicles.
- e) Sheltered areas.
- f) Tables and/or benches.

12.5.9.2 Truck parking bays shall include, at a minimum, rubbish bins, shade and all weather pavements. If possible, sheltered areas and tables and benches should be provided. Rest area selection is based on the provision of natural shade, rubbish bins, all weather surfaces and sealed pavements, and the quality and cleanliness of toilets and running water provided.

12.5.9.3 Provision for People with Disabilities shall also be taken into account when design rest Area. This also includes access to and the use of rest area facilities, provision of suitable toilets, parking spaces, and appropriately graded and treated footways and ramps.

12.5.10 Additional Facilities

Additional facilities such as toilets and drinking water shall be provided in rest areas where they can be adequately justified based on estimated use and the cost of maintenance and cleaning. The provision of additional facilities, such as toilets, showers and drinking water, should be considered on a site by site basis, taking into consideration the availability of required utilities, the installation requirements and the costs associated with ongoing facility maintenance. The ongoing maintenance and upkeep of these facilities should be documented and implemented.

12.5.11 Cross-Border Compatibility

The State and Territory road authorities are recommended to adopt common guidelines for the provision of rest areas and service centres, and coordinate their provision across state and territory borders, so that a consistent level of service is provided along important routes.

In order to maximise the benefits of rest areas and service centres it is imperative that the provision of these facilities be closely coordinated across state and territory borders. Duplication of such facilities may lead to under-utilisation of one or both facilities and adversely affect their viability.

DRAFT FOR PUBLIC REVIEW